

# PENTAX™

Digital Camera

# Optio 230

## Operating Manual

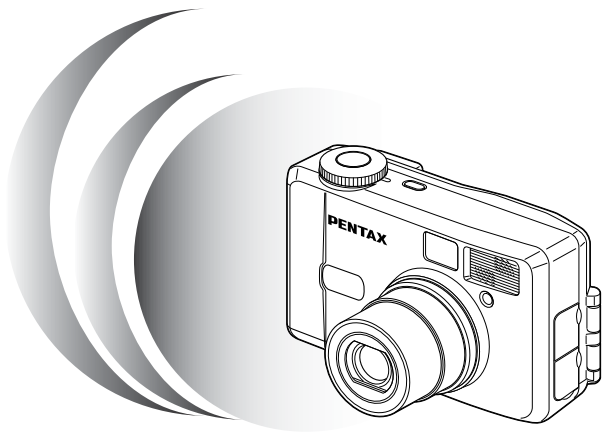

To ensure the best performance from your camera, please read the Operating Manual before using the camera.

Thank you for buying the Pentax Optio 230 Digital Camera. Please read this manual before using the camera in order to get the most out of all the features and functions. Keep this manual safe, as it can be a valuable tool in helping you to understand all the camera's capabilities.

### **Regarding copyrights**

Images taken using the Optio 230 that are for anything other than personal enjoyment cannot be used without permission according to the rights as specified in the Copyright Act. Please take care, as there are even cases where limitations are placed on taking pictures even for personal enjoyment during demonstrations, industrial enterprise or as items for display. Images taken with the purpose of obtaining copyrights also cannot be used outside the scope of use of the copyright as laid out in the Copyright Act, and care should be taken here also.

### **Regarding trademarks**

- CompactFlash and CF are trademarks of SanDisk Corporation.
- PENTAX is a trademark of Asahi Optical Co., Ltd.
- Optio is a trademark of Asahi Optical Co., Ltd.
- All other brands or product names are trademarks or registered trademarks of their respective companies.
- The USB driver uses software developed by Phoenix Technologies Ltd.

### **To users of this camera**

- There is a possibility that recorded data may be erased or that the camera may not function correctly when used in surroundings such as installations generating strong electromagnetic radiation or magnetic fields.
- The liquid crystal panel used in the LCD display is manufactured using extremely high precision technology. Although the level of functioning pixels is 99.99% or better, you should be aware that 0.01% or fewer of the pixels may not illuminate or may illuminate when they should not. However, this has no effect on the recorded image.
- There is a possibility that the illustrations and the display screen of the LCD monitor in this manual are different from the actual product.

## FOR SAFE USE OF YOUR CAMERA

Sufficient attention has been paid to the safety of this product but please pay particular attention to the warnings indicated by the following symbols during use.



**Warning** These symbols indicate that it is possible that the user may experience serious difficulties if the warnings are not heeded.



**Caution** These symbols indicate that it is possible that the user may experience minor or middling difficulties or physical difficulties if the warnings are not heeded.



**Warning:**

- Do not attempt to take the camera apart or remodel the camera. High voltages are present within the camera, and there is therefore a danger of electric shocks.
- If the inside of the camera should become exposed as a result of, for example, the camera being dropped, please do not under any circumstances touch such exposed portions, as there is a danger of receiving an electric shock.
- Wrapping the strap of the camera around your neck is also dangerous, and please take care that small children do not hang the strap around their necks.
- Use an AC adapter that are of the power and voltage specified for exclusive use with this product. The use of an AC adapter other than that specified exclusively for use with this product may cause fire or electric shocks.
- If the camera emits smoke or a strange smell, or in the event of any other irregularity, stop using the camera immediately, remove the battery or disconnect the AC adapter and contact your nearest Pentax service center. Continued use of the camera may result in fire or electric shock.
- Discontinue use of the AC adapter during thunderstorms. This can cause a fire or electrical shock.



**Caution:**

- Never try to disassemble, short or recharge the battery. Also, do not dispose of the battery in fire, as it may explode.
- Remove the battery from the camera immediately if it becomes hot or begin to smoke.  
Be careful not to burn yourself during removal.
- Some portions of the camera heat up during use, so please take care, as there is a risk of low temperature burns if such portions are held for long periods of time.

## Care to be Taken During Handling

- Do not clean the product with organic solvents such as thinner or alcohol benzene.
- Places of high temperature and humidity should be avoided. Particular care should be taken regarding vehicles, which can become very hot inside.
- Storing the camera where pesticides and chemicals are handled should be avoided. Remove from case and store in a well-ventilated place to prevent the camera from becoming moldy during storage.
- Do not use the camera where it may come in contact with rain, water or any other liquid, because the camera is not weather, water, or liquid resistant. Should the camera get wet from rain, splashing water, or any other liquid, wipe it off immediately with a dry soft cloth.
- Ensure that the camera is not subjected to substantial vibrations, shocks or pressure. Place the camera on a cushion for protection when the camera is subjected to the vibrations of a motorbike, car, or ship, etc.
- The liquid crystal display will become black at temperatures of approximately 60°C but will return to normal when normal temperatures are returned to.
- The display response speed of the liquid crystal becomes slow at low temperatures but this is due to the properties of the liquid crystal and is not a fault.
- Remove dust from the lens and viewfinder using a blower or clean off dust using a lens brush.
- Periodic checks are recommended every 1 to 2 years in order to maintain high-performance.
- When the camera has not been used for a long time, please, without fail, try out the camera to confirm that it is still working properly, particularly prior to taking important pictures (such as at a wedding or during travelling). No guarantee can be given with regards to collateral damage (costs incurred as a result of taking pictures, loss of benefits that were to be obtained through taking pictures) that may cause this product to fail.
- If the camera is subjected to rapid temperature changes, drops of water appear on the inside and outside of the camera. Therefore put the camera in a bag or plastic bag, and take the camera out when the difference in temperature has subsided.
- The temperature range in which the camera can be used is 0°C to 40°C.
- Take care to ensure that garbage, dirt, sand, dust, water, toxic gases, salt, etc. do not enter within the camera, as this may cause the camera to become damaged. If rain or drops of water get onto the camera, please wipe dry.
- Please refer to "Precautions When Using a CF Card" (p.14) regarding the CompactFlash CF card.

# Contents

FOR SAFE USE OF YOUR CAMERA.....	1
Care to be Taken During Handling .....	2
Contents .....	3
Contents of the Operating Manual .....	5
Checking the Contents of the Package .....	6
Names of Parts.....	7
Names of Operating Parts.....	8
<b>Getting Started.....</b>	<b>9</b>
Attaching the Strap .....	9
Powering the Camera .....	10
Installing the Battery.....	10
Using the AC Adapter (optional) .....	12
Installing or removing the CF Card.....	13
Initial Settings .....	15
Setting the Display Language .....	15
Setting the Home Town .....	16
Setting the D.S.T Mode .....	16
Setting the Video Output Format.....	17
Setting the Date and Time .....	17
<b>Quick Start.....</b>	<b>20</b>
Taking Still Pictures .....	20
Playing Back Still Pictures .....	22
Playing Back the Last Image Taken (Easy View) .....	22
Playing Back a Single Image .....	23
How to use the CF Card.....	24
<b>Common Operations .....</b>	<b>26</b>
Turning the Camera On and Off .....	26
Changing the Mode .....	27
Using the Button Functions .....	28
Capture Mode.....	28
Playback Mode .....	29
Using the Menus.....	30
How to Use the Menus .....	30
Menu List .....	32
<b>Taking Pictures .....</b>	<b>34</b>
Displaying Shooting Information (Display Mode).....	34
Taking Pictures .....	35
Taking Still Pictures in Auto Mode (Auto Mode) .....	35
Taking Pictures with All the Functions Set (Full Selectable Mode).....	36
Taking Dark Scenes (Night-Scene Mode).....	37
Continuous Shooting .....	38
Using the Self-Timer.....	39
Taking Movie Pictures (Movie Picture Mode) .....	40
Using the Zoom .....	42
Taking a Picture of Yourself (Self-Portrait Mode).....	44
Taking Stereo Pictures (3D image mode) .....	45
Automatically Changing the Shooting Conditions (Auto bracket).....	50
Setting the Shooting Functions .....	52
Selecting a Focus Mode .....	52
EV Compensation .....	54
Selecting the Flash Mode.....	55
Selecting the Recorded Pixels .....	56
Selecting the Quality Levels .....	57
Adjusting the Color Balance according to Lighting (White Balance).....	58

Changing the AF Area (Focusing Area).....	60
Setting the Light Metering Range to Determine the Exposure (AE Metering).....	61
Setting the ISO Speed (ISO Speed) .....	62
Selecting the Color Mode (Color).....	63
Setting the Instant Review Time (Instant Review).....	64
Setting the Sharpness (Sharpness).....	65
Setting the Saturation (Saturation).....	66
Setting the Contrast (Contrast) .....	67
Saving the Settings (Memory).....	68
Saving the Menu Items (Mode Memory).....	68
Saving the Exposure Compensation Setting.....	69
<b>Playback/Erasing .....</b>	<b>70</b>
Playing Back Images on the Camera .....	70
Playing Back Still Pictures.....	70
Zoom Display.....	70
Playing Back Movie Pictures .....	71
Displaying Shooting Information (Display mode) .....	72
Nine-image Display .....	73
Slideshow .....	74
Erasing Images.....	75
Erasing a Single Image .....	75
Erasing All Images .....	76
Protecting Images from Deletion (Protect).....	77
Viewing Images on a TV.....	78
Setting the Printing Service.....	79
Printing Single Image .....	79
Printing All Images .....	81
Viewing images with Windows PC .....	82
About the included software.....	82
System environment.....	82
Installing the software.....	83
Connecting the camera and PC.....	93
Viewing images on your PC .....	94
Disconnecting the camera from your PC .....	95
Viewing Images with Macintosh .....	98
About the included software.....	98
System environment.....	98
Installing the software.....	99
Connecting the camera and your Macintosh.....	100
Viewing images on your Macintosh.....	101
Disconnecting the camera from your Macintosh.....	101
<b>Settings.....</b>	<b>102</b>
Camera Settings .....	102
Formatting a CF Card .....	102
Setting the Date Style .....	103
Changing the Date/Time .....	104
Changing the Display Language .....	104
Changing the Video Output Format.....	105
Setting the Beep.....	105
Setting the World Time .....	106
Powersaving Function (Sleep Timeout).....	108
Auto Power Off Function .....	108
Setting the Brightness Level.....	109
Resetting to Default Settings (Reset).....	109
<b>Appendix.....</b>	<b>110</b>
List of City Names .....	110
Messages .....	111
Troubleshooting .....	113
Main Specifications.....	116
WARRANTY POLICY .....	118

## Contents of the Operating Manual

This Operating manual contains the following chapters.

### ● Getting Started

This chapter explains what you need to do after purchasing the camera before you start taking pictures. Be sure to read it and follow the instructions.

### ● Quick Start

This chapter explains the simplest way to take pictures and play back images. Use it if you want to start taking pictures straightaway. It also tells you how to use the CF card.

### ● Common Operations

This chapter explains common operations such as the functions of the mode dial and buttons, and how to use the menus. For more details, refer to the respective [Taking Pictures], [Playback/Erasing] and [Settings] chapters.

### ● Taking Pictures

This chapter explains the various ways of capturing images and how to set the relevant functions.

### ● Playback/Erasing

This chapter explains how to play back images on the camera or on a TV and how to delete images.



### ● Settings

This chapter explains how to set the camera-related functions.

### ● Appendix

This tells you about the messages displayed on the LCD monitor and what to do in the event of trouble.

The meanings of the symbols used in this Operating manual are explained below.

	indicates the reference page number for an explanation of the related operation.
	indicates information that is useful to know.
	indicates precautions to be taken when operating the camera.

## Checking the Contents of the Package



Camera  
Optio 230

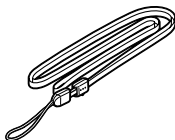

Strap  
O-ST5

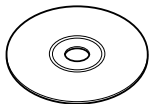

Software (CD-ROM)  
S-SW5



Video cable I-VC2

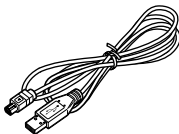

USB cable I-USB2

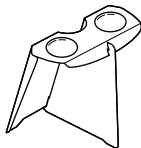

3D Image Viewer  
O-3DV1

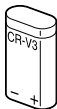

Lithium battery  
CR-V3



Operating Manual  
this manual



## Names of Parts

### Front

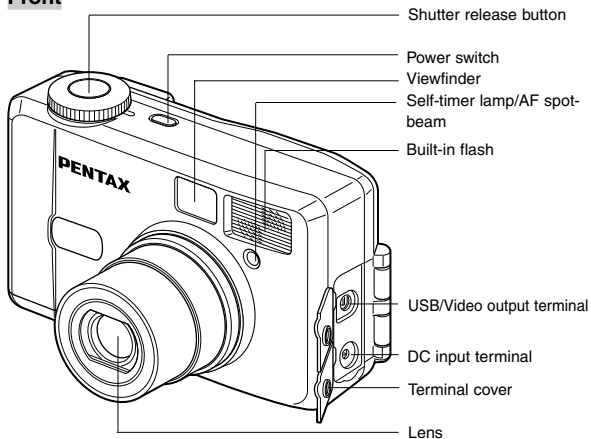

### Back

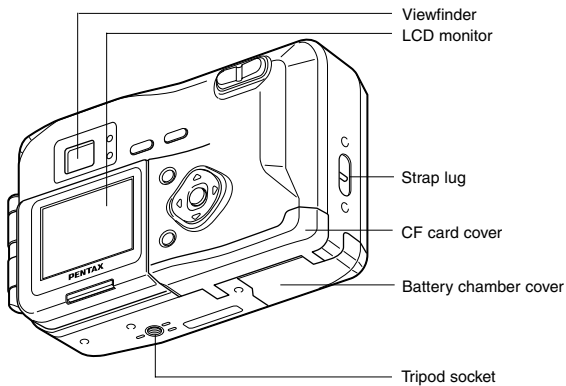

## Names of Operating Parts

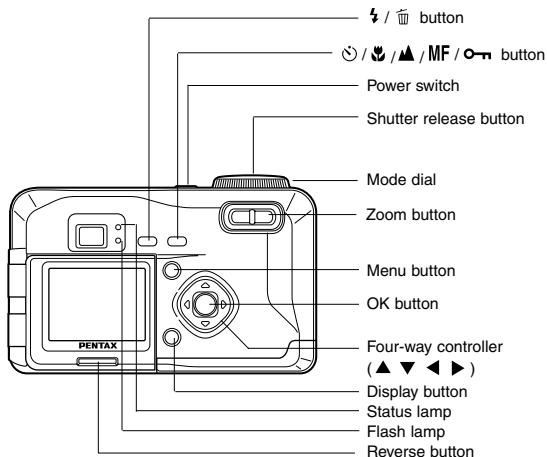

### ● Guide indications

A guide to available button operation is displayed on the LCD monitor during operation. The buttons are indicated as shown below.

Four-way controller (▲)	▲	Zoom button (Only for digital zoom and magnified playback)	
Four-way controller (▼)	▼	Display button	DISP
Four-way controller (◀)	◀	🗑️ button	
Four-way controller (▶)	▶	🗑️ button	
Menu button		Shutter release button	
OK button		Reverse button	

# Attaching the Strap

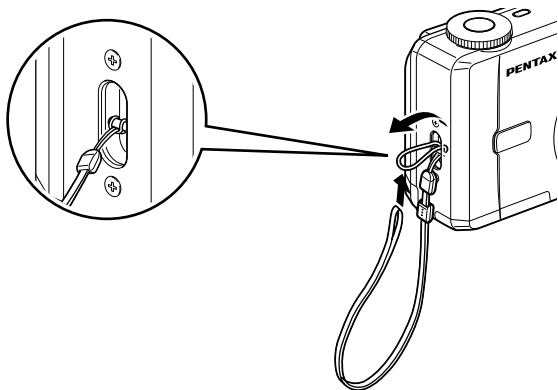

Pass the narrow end of the strap through the strap lug and pass the other end through the loop.

# Powering the Camera

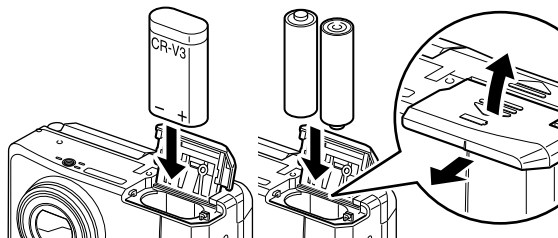

## Inserting the Battery

Insert the battery into the camera. When using the camera for the first time, insert a new battery.

- 1** Slide the battery chamber cover sideways and lift it up.
- 2** Insert the battery in the direction indicated by the (+) (-) marks inside the battery chamber.
- 3** Close the battery chamber cover and slide it back into place.



- If you intend to use the camera for a long period, use of the AC adapter D-AC5 (optional) is recommended. (  p.12)



- Do not open the battery chamber cover or remove the battery when the camera is turned on.
- If you do not intend to use the camera for a long time, remove the battery.
- If the camera is left without the battery for a long time, the date setting will be reset.
- Insert the battery correctly. If the battery is incorrectly oriented, it may cause a malfunction.

## ● Approximate Operating Time (when new batteries are loaded)

		Number of recordable images		Playback time
		LCD monitor ON	LCD monitor OFF	
With the flash fired for 50% of the shots	CR-V3 lithium	500	650	—
	AA lithium	400	450	—
	AA NiMH	200	250	—
	AA alkaline	100	200	—
Without the flash	CR-V3 lithium	600	850	240
	AA lithium	450	650	180
	AA NiMH	250	300	100
	AA alkaline	150	300	30

\* The above table is based on Pentax measuring conditions and may vary depending on capture mode and shooting conditions.



Performance of the battery may deteriorate in low temperatures.

## ● Battery Level Indicator

You can check the battery level by the  symbol displayed on the LCD monitor.

 (lit green) : Adequate power remains.



 (lit yellow) : Battery remains half.



 (lit red) : Battery is exhausted.



[Battery depleted] : After the message is displayed, the camera will turn off.

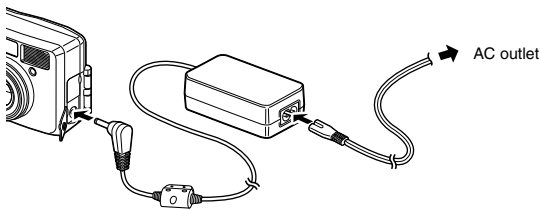

## Using the AC Adapter (optional)

If you intend to use the LCD monitor for a long time or connect the camera to a PC, use of the AC adapter D-AC5 (optional) is recommended.

- 1** Make sure that the camera is turned off before opening the terminal cover.
- 2** Connect the DC terminal on the AC adapter to the DC input terminal on the camera.
- 3** Connect the AC plug cord to the AC adapter.
- 4** Plug the AC plug cord into the power outlet.



When using the AC adapter, the battery level indicator is not displayed on the LCD monitor.



- Make sure that the camera is turned off before connecting or disconnecting the AC adapter.
- Make sure that the AC plug cord and connecting cord are inserted securely. If the cord becomes disconnected while you are taking pictures, the data may be lost.
- When using the AC adapter D-AC5, be sure to read the operation manual accompanying the AC adapter.

# Installing or removing the CF Card

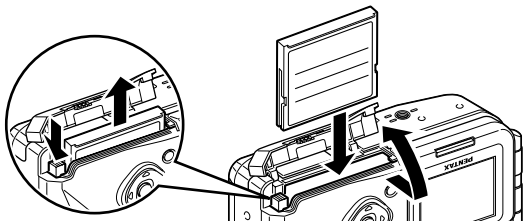

Captured images are recorded on the CompactFlash (CF) card. Make sure that the camera is turned off before inserting or removing the CF card (optional).

## Installing the Card

- 1** Open the CF card cover.
- 2** Orient the card with the surface of the card having the ▲ symbol facing towards the lens and with the pin-connector edge of the card towards the slot and insert fully.
- 3** Close the CF card cover.

## Removing the Card

- 1** Open the CF card cover.
- 2** Press the CF card eject button and remove the card.
- 3** Close the CF card cover.

### Caution

- If you open the CF card cover when the camera is turned on, a warning beep will sound and the camera will be forcibly turned off.
- If you open the CF card cover while recording an image on the CF card, the recording operation will be terminated (the image will not be saved).

## ● Approximate Number of Recordable Images and Recorded pixels/Quality levels

Quality levels Recorded pixels	TIFF	Best (★★★)	Better (★★)	Good (★)	Movie images
1600 × 1210	2	—	—	—	—
1600 × 1200	—	Approx. 14	Approx. 29	Approx. 64	—
1024 × 768	—	Approx. 26	Approx. 53	Approx. 94	—
640 × 480	—	Approx. 53	Approx. 94	Approx. 133	—
320 × 240	—	—	—	—	2

- The above table indicates is the number of images when using a 16MB CF card.
- The above table is based on standard shooting conditions specified by PENTAX and may vary depending on the subject, shooting conditions, capture mode, CF card, etc.

### Precautions When Using a CF Card

- Make sure that the camera is turned off before opening the CF card cover.
- Care should be taken if you remove the CF card immediately after using the camera, as the card may be hot.
- Do not open the CF card cover or turn the camera off while data is being recorded on the card or transferred to another device as this may cause the data to be lost or the card to be damaged.
- Do not bend the CF card or subject it to violent impact. Keep it away from water and store away from high temperature.
- Be sure to format unused CF cards or CF cards that have been used on another camera. Refer to "Formatting a CF Card" (p.102) for instructions on formatting.
- Never open the CF card cover during formatting as this may cause the card to be damaged and become unusable.
- Data recorded on a CF card with the Optio 230 cannot be played back accurately on the Optio 330 or Optio 430. Similarly, data recorded with the Optio 330 or Optio 430 cannot be played back accurately on the Optio 230.
- The data on the CF card may be erased in the following circumstances. Pentax does not accept any liability for data that is erased
  - when the CF card is mishandled by the user.
  - when the CF card is exposed to static electricity or electrical interference.
  - when the card has not been used for a long time.
  - when the card is ejected, the AC adapter is disconnected or the battery is removed while the data on the card is being accessed (when the status lamp and flash lamp are blinking green and red).
- The CF card has a limited service life. If it is not used for a long time, the data on the card may become unreadable. Be sure to make a backup of important data on a PC.
- Avoid using or storing the card where it may be exposed to static electricity or electrical interference.
- Avoid using or storing the card in direct sunlight or where it may be exposed to rapid changes in temperature or to condensation.



# Initial Settings

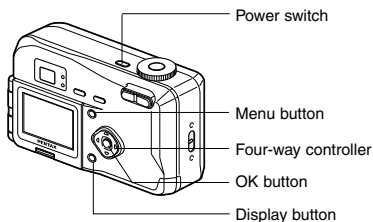

If the initial settings screen appears when you turn the camera on, follow the procedure below to set the display language, Home Town, DST, video output format and current date and time. If the date and time appear at the bottom right of the LCD monitor when you turn the camera on for the first time, follow the instructions for “Changing the Date/Time” (p.104) to set the correct date and time.

## Setting the Display Language

You can choose the language in which the menus, error messages, etc. are displayed.

- 1 Turn the camera on.**
- 2 Use the four-way controller ( ◀ ▶ ) to select the display language.**  
The default setting is English.
- 3 Press the four-way controller ( ▼ ).**  
The screen for setting the next item will be displayed.

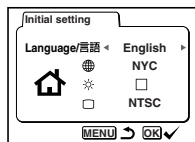

You can change the setting after it has been made. Refer to “Changing the Display Language” (p.104).

## Setting the Home Town

You can choose the city (Home Town) in which you will use the camera.

- 1 Press the four-way controller ( ◀ ▶ ) to select the desired city (Home Town).
- 2 Press the four-way controller ( ▼ ).  
The screen for setting the next item will be displayed.

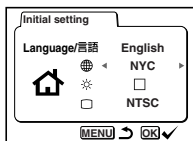

- See p.110 for the list of cities and corresponding code names.
- You can change the setting after it has been made. Refer to “Setting the World Time” (p.106).

## Setting the D.S.T. Mode

You can choose whether or not to display the D.S.T mode.

- 1 Use the four-way controller ( ◀ ▶ ) to select  (On) or  (Off).  
The default setting is  (Off).
- 2 Press the four-way controller ( ▼ ).  
The screen for setting the next item will be displayed.

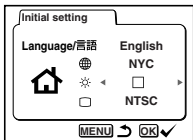

You can change the setting after it has been made. Refer to “Setting the World Time” (p.106).

## Setting the Video Output Format

You can choose the output format (NTSC or PAL) for taking or playing back pictures using a TV monitor.

- 1 Use the four-way controller (◀ ▶) to select the video output format.

The default setting is NTSC.

- 2 Press the OK button.

The screen for setting the date and time will be displayed.

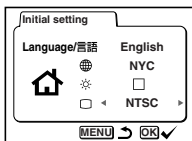

- You can change the setting after it has been made. Refer to “Changing the Video Output Format” (p.105).

## Setting the Date and Time

Set the current date and time.

- 1 Use the four-way controller (▲ ▼) to change the month.

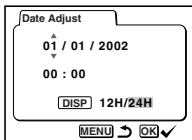

- 2 Press the four-way controller (▶).  
▲ and ▼ will be displayed above and below the day.

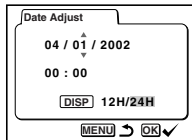

- 3** Use the four-way controller (▲ ▼) to change the day and press the four-way controller (▶).  
▲ and ▼ will be displayed above and below the year.

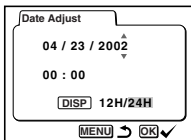

- 4** Repeat Step **3** to change the [year] [hour] and [minutes].

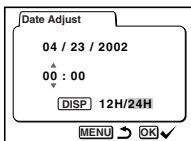

- 5** Use the Display button to select the 12-hour or 24-hour display format.

- 6** When you have finished the settings, press the OK button when the clock reaches 00 seconds.

The screen confirming the settings will be displayed and the camera is ready to take a picture.

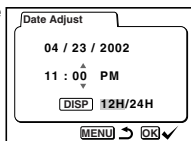

- You can cancel setting operation and switch to Capture mode by pressing the MENU button. In this case, the initial settings screen will be displayed next time you turn the camera on.
- You can change the settings after they have been made. Refer to “Changing the Date/Time” (p.104).



## Taking Still Pictures

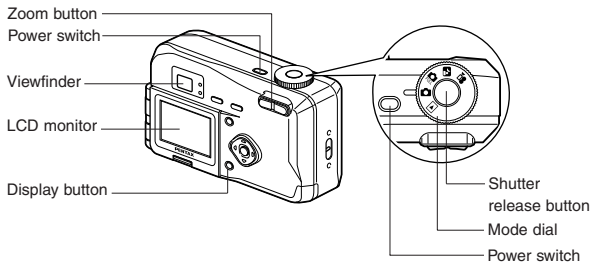



For the simplest procedure to take still pictures:  
The flash fires automatically depending on the light conditions.

- 1 Press the power switch.**  
The camera will turn on.
- 2 Set the mode dial to .**
- 3 Turn the LCD monitor on.**

Press the Display button to display the shooting screen on the LCD monitor.

The focus frame in the middle of the LCD monitor indicates the zone of automatic focusing. You can change the size of the subject by pressing the Zoom button.

 makes the subject bigger.

 makes the subject smaller.

You can check the size of the subject by looking through the viewfinder.



Focus frame

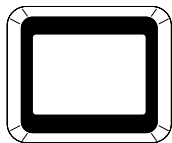

Viewfinder



As there is no focus frame in the viewfinder, be sure to check the focusing area on the LCD monitor.

**4 Press the shutter release button.**

The image will be displayed on the LCD monitor for 0.5 seconds (Instant Review) and recorded on the CF card. (The green and red lamps on the right of the viewfinder blink alternately while the image is being recorded on the CF card.)

**Using the Shutter Release Button**

The shutter release button works in a two-step action.

**● Press halfway**

When the shutter release button is pressed lightly (halfway), the focus, exposure and white balance are locked. You can find the following information on the LCD monitor, the status lamp and the flash lamp.

The shutter speed and aperture settings are only displayed when the shutter release button is pressed lightly (halfway).

**① Focusing area**

If the subject is in focus, the frame will light green. If the subject is not in focus, the frame will not appear.

**② Flash symbol**

The flash symbol indicates the status of the flash when the shutter release button is pressed.

**Status lamp & Flash lamp (on the right of the viewfinder)**

status	Status lamp (green)	Flash lamp (red)
lit	Subject is in focus	Flash is charged
blink	Subject is not in focus	Flash is charging

**● Pressed down fully**

The picture is taken.

**Instant Review**

The Instant Review default setting is 0.5 seconds. During this time you can delete the image by pressing the  button (The [Delete] menu will be displayed.), and selecting [Delete].

Setting the Instant Review Time  p.64

## Playing Back Still Pictures

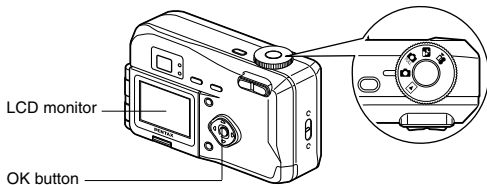

### Playing Back the Last Image Taken (Easy View)

You can display the last still picture taken.

**1** Press the OK button after taking a picture.

The last image taken will be displayed on the LCD monitor. During this time you can erase the image by pressing the  button (The [Delete] menu will be displayed.), and selecting [Delete].

Press the OK button again to return to shooting status.

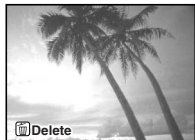

- You can enlarge the image displayed on the LCD monitor by pressing the zoom lever.

Playing Back Still Pictures  p.70



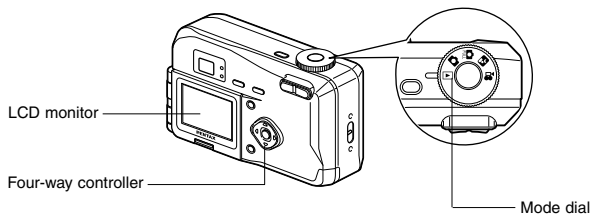

## Playing Back a Single Image

You can play back still pictures one at a time.

- 1 Set the mode dial to .**

An image will be displayed on the LCD monitor.

- 2 Press the four-way controller (   ).**



displays the previous image.



displays the next image.



- In the case of movie pictures, the first frame will be displayed.
- If there are no images stored on the CF card, the [No images in camera] message will be displayed, and if there is no CF card in the camera, the [No card in camera] message will be displayed.

## How to Use the CF Card

Images taken with the Optio 230 camera are recorded on the CF card. You can view the images recorded on the card on the camera itself, transfer them to your PC and print them out.



### Viewing images on the camera

One of the advantages of a digital camera is that it enables you to view your pictures immediately after you have taken them. You can check the composition and brightness and take the picture again if you are not satisfied.

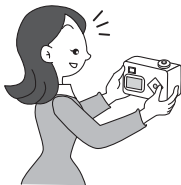

Playing Back Still Pictures  p.22

### Viewing images on a TV

If you want to show your pictures to friends, you can display them on your TV monitor. To view images on your TV, connect the camera to the TV with the video cable.

Viewing Images on a TV  p.78



## Viewing images on a PC

You only need to install the USB driver the first time. After that, you can view recorded images and edit them on the PC just by connecting the camera to the PC with the USB cable and downloading the images. Or you can remove the CF card from the camera and transfer the data to your PC using a card reader. If you use a laptop computer, you can transfer the image data by fitting the CF card into the card adapter and inserting the card adapter into the card slot.

Viewing Images with Windows PC  p.82

Viewing Images with Macintosh  p.98



## Printing images by a printing service

By selecting the pictures you want to have printed and specifying the number of prints in advance on the CF card, you can take the card to a DPOF-compatible (Digital Print Order Format) printing service and have prints made.

Setting the Printing Service  p.79

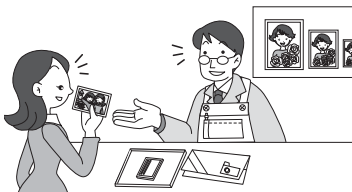

# Turning the Camera On and Off

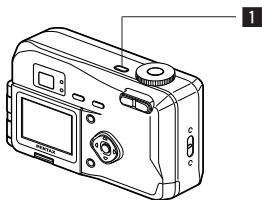

---

Use the power switch to turn the camera on and off.

**1 Press the power switch.**

The camera will turn on.

When the camera is turned on, the lens cover opens and the lens extends.

Press the power switch again to turn the camera off.







---

If you turn the camera on in Playback mode, the lens cover remains closed and the lens does not extend.

# Changing the Mode





Capture mode is for taking pictures and Playback mode is for playing back or erasing images. The mode is set by the mode dial.

## Capture Mode

	Auto mode	Most of the settings are made automatically by the camera when a picture is taken.	p.35
	Full selectable mode	You can set all the functions as you like when a picture is taken.	p.37
	Night-scene mode	This mode is for taking dark scenes such as night views.	p.36
	Movie picture mode	This mode is for taking moving images.	p.40

## Playback Mode

	Playback mode	This mode is for playing back recorded images.	p.70
---	---------------	--	------

- 1 Turn the mode dial so that the mark is on     or  .

# Using the Button Functions

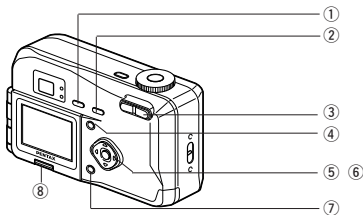

## Capture Mode

- ① **Flash button**  
Changes the flash mode. (☞ p.55)
- ② **Self-timer/MF button**  
Changes the shooting mode as follows.  
Using the Self-timer (☞ p.39)  
Using macro mode (☞ p.52)  
Infinity landscape mode (☞ p.52)  
Manual focus (☞ p.53)
- ③ **Zoom button**  
Changes the size of the subject. (☞ p.42)
- ④ **Menu button**  
Displays the active menus in Capture mode. (☞ p.32)
- ⑤ **Four-way controller (◀ ▶)**  
Changes the EV compensation in mode. (☞ p.54)
- ⑥ **Four-way controller (▲ ▼)**  
Adjusts the focus in MF mode. (☞ p.52)
- ⑦ **Display button**  
Changes the information displayed on the LCD monitor. (☞ p.34)
- ⑧ **Reverse button**  
Reverse the image from right to left. (The image is not recorded in reverse. ☞ p.44)





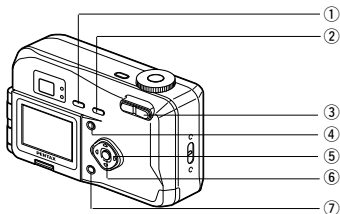

MF (manual focus) and EV compensation are disabled in Auto mode . (☞ p.35)



## Playback Mode

- ① **Trash button**  
Erases the image. (☞ p.75)
- ② **Lock button**  
Protects the image from erasure. (☞ p.77)
- ③ **Zoom button**  
Changes the size of the image displayed on the LCD monitor. (☞ p.70)
- ④ **Menu button**  
Displays the active menus in Play mode. (☞ p.33)
- ⑤ **Four-way controller (◀ ▶)**  
Displays images one by one. (☞ p.23)
- ⑥ **OK button**  
Displays nine images at once. (☞ p.73)
- ⑦ **Display button**  
Changes the information displayed on the LCD monitor. (☞ p.72)











# Using the Menu

When you press the Menu button, the menu is displayed on the LCD monitor. You can set the shooting functions in Capture mode (     ) or the playback functions in Playback mode (  ).

You can set the camera functions in both Capture mode and Playback mode.

## How to Use the Menu

When you are making settings from a menu, a guide to operation is displayed on the LCD monitor.

- 1 Press the Menu button.**  
The menu screen will be displayed. The selected area will be displayed in a green frame.
- 2 Press the four-way controller (   ).**  
Use the four-way controller (   ) to select the menu screen.
- 3 Use the four-way controller (   ) to select an item.**  
Use the four-way controller (   ) to move the frame up or down.
- 4 Use the four-way controller (   ) to change the setting.**
- 4' If there is a Select screen, use the four-way controller (  ) to move to the Select screen.**  
When you have finished making the settings, press the OK button to return to the menu.
- 5 Press the OK button.**  
The settings will be saved and the screen will return to shoot- or playback status.

### Caution

- If you press the Menu button and leave the menu screen, any changes to setting will not be saved.
- Even if you press the OK button and leave the menu screen, if you remove the battery before turning off the camera or do not otherwise turn off the camera correctly, any changes to setting will not be saved.



## Example of shooting (in Capture mode)

### 1 Menu button

[Rec.Mode] menu

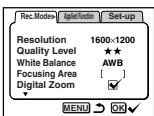

[Applied Function] menu

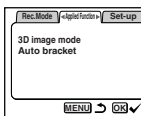

[Set-up] menu

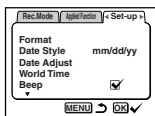

### 2



### 3

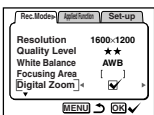

### 4

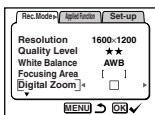

(Ex.) Turning the digital zoom off

### 3

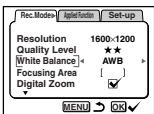

### 4'

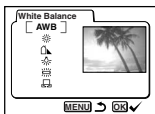

(Ex.) Adjusting the white balance

### 3

To the next screen



When you press the Menu button in Playback mode, the Playback mode menu will be displayed.

Press the four-way controller (◀▶) to switch to the [Playback] or [Set-up] menu.

## Active Menus in Capture Mode

### ● [Rec.Mode] Menu

Item	Description	Default Setting	Reference	Auto mode
Resolution	For selecting the size of recorded pixels.	1600 × 1200	p.56	Adjustable
Quality Level	For selecting the image compression rate.	★★	p.57	Adjustable
White Balance	For adjusting the color balance according to lighting.	AWD (Auto)	p.58	Fixed at default setting
Focusing Area	For changing the Area of the autofocus.	[ ](Wide)	p.60	Fixed at default setting
Digital Zoom	For taking digital zoom pictures.	<input checked="" type="checkbox"/> (On)	p.43	Fixed at default setting
AE Metering	For setting the metering method to determine the exposure.		p.61	Fixed at default setting
ISO Speed	For setting the ISO speed.	Auto	p.62	Fixed at default setting
Color	For selecting the color mode.	Full	p.63	Fixed at default setting
Instant Review	For setting the instant review time.	0.5sec	p.64	Fixed at default setting
Memory	For saving the shooting function settings when the camera is turned off.		p.68	Fixed at default setting
Exp. comp. memory	For saving the exposure compensation setting when the camera is turned on.	<input type="checkbox"/> (Off)	p.69	Fixed at default setting
Continuous Shooting	For taking pictures continuously while the shutter release button is pressed.	<input type="checkbox"/> (Off)	p.38	Fixed at default setting
Sharpness	For setting the sharpness.	Normal	p.65	Fixed at default setting
Saturation	For setting the saturation.	Normal	p.66	Fixed at default setting
Contrast	For setting the contrast.	Normal	p.67	Fixed at default setting

### ● [Applied Function] Menu

Item	Description	Default Setting	Reference	Auto mode
3D image mode	For taking 3-D pictures.	Parallel method	p.45	—
Auto bracket	For setting the shooting conditions such as exposure, saturation and sharpness.	Exposure	p.50	—

## Active Menus in Playback Mode

### ● [Playback] Menu

Item	Description	Default setting	Reference
Slideshow	Recorded images are played successively.	3s (3 sec. intervals)	p.74
DPOF	For setting the printing service.	—	p.79

## Active Menus in Capture/Playback Mode

### ● [Set-up] Menu

Item	Description	Default Setting	Reference	Auto mode
Format Card	For formatting the CF card	Cancel	p.102	Adjustable
Date Style	For setting the date style	Set according to the Language default setting	p.103	Adjustable
Date Adjust	For adjusting the date and time	01/01/2002	p.104	Adjustable
World Time	For setting the world time	<input type="checkbox"/> (Off)	p.106	Adjustable
Beep	For adjusting the beep sound when a button is pressed	<input checked="" type="checkbox"/> On	p.105	Adjustable
Language	For changing the language in which menus and messages are displayed	English	p.104	Adjustable
Video Out	For setting the video output format	Set according to the Language default setting	p.105	Adjustable
Sleep Timeout	For setting the power-saving function	1min.	p.108	Adjustable
Brightness Level	For setting the brightness of the LCD monitor	Normal	p.109	Adjustable
Reset	For returning the camera settings to defaults	Cancel	p.109	Adjustable

**Display On**

Shooting information is displayed.

- ① Flash mode
- ② Focus mode/ Self-timer
- ③ Continuous Shooting mode On
- ④ Applications
- ⑤ AF frame
- ⑥ Remaining images
- ⑦ Shutter speed & aperture
- ⑧ Battery symbol
- ⑨ Date & time

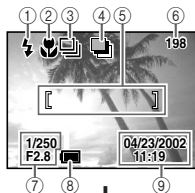
**Display Off**

No shooting information is displayed.

- Only the AF frame is displayed in auto focus mode.
- If there is any change in the battery level, the battery symbol is displayed.
- If there is any change in such as Flash mode, the mode you have changed is displayed for a few seconds.

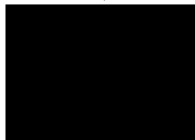

Display On

**LCD Monitor Off**

The LCD monitor is turned off.

Saving the Display Mode  p.68



When using the AC adapter, the battery level indicator is not displayed on the LCD monitor.



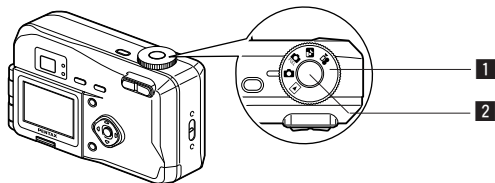

LCD Monitor Off cannot be set in Movie Picture mode.

# Taking Pictures



## Taking Still Pictures in Auto Mode (Auto Mode)

By setting the mode dial to , most of the settings will be made automatically by the camera when a picture is taken.

- 1 Set the mode dial to .**
- 2 Press the shutter release button.**  
The picture will be taken.



In Auto mode, with the exception of certain functions, the menu settings are fixed at the default settings. See "Menu List" (p.32) for the menu where the settings can be changed.

Using the Shutter Release Button  p.21

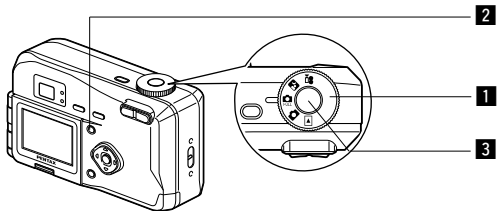

## Taking Pictures with All the Functions Set (Full Selectable Mode)

By setting the mode dial to  , you can set all of the functions.

**1** Set the mode dial to  .

**2** Press the Menu button.

The Menu screen will be displayed. For details of how to make the settings, see “How to Use the Menus” (p.30).

**3** Press the shutter release button.

The picture will be taken.

Using the Shutter Release Button  p.21

Playing Back Images  p.22

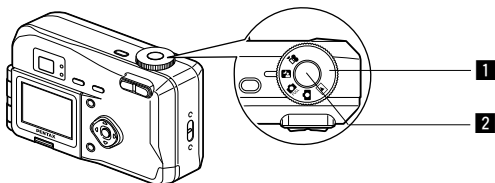

## Taking Dark Scenes (Night-Scene Mode)

The appropriate settings are made automatically for taking dark scenes such as night views.

- 1 Set the mode dial to .**
- 2 Press the shutter release button.**  
The picture will be taken.

Using the Shutter Release Button  p.21  
Playing Back Images  p.22



As the shutter speed becomes slow in night-scene mode, camera shake should be avoided.

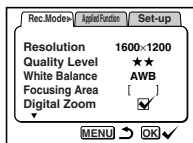
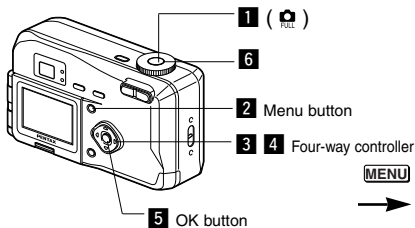

## Continuous Shooting

Pictures are taken continuously while the shutter release button is pressed.

**1** Set the mode dial to .

**2** Press the Menu button.  
The [Rec. Mode] menu will be displayed.

**3** Press the four-way controller (▼) to select [Continuous Shooting].

**4** Press the four-way controller (▶) to select  (On).

**5** Press the OK button.  
The (Continuous Shooting) icon will be displayed on the LCD monitor.

**6** Press the shutter release button.  
Pictures will be taken continuously while the shutter release button is pressed, and stop when the button is released.

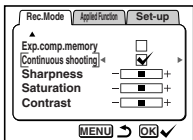

Playing Back Images p.22



- You can continue shooting until the CF card is full.
- The interval will vary according to the [Resolution] and [Quality Level] setting.



- The flash will not fire in Continuous Shooting mode.
- Continuous shooting is not possible in Auto and Movie picture mode.



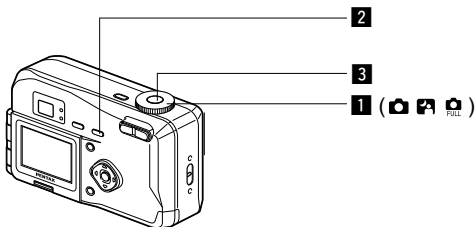

## Using the Self-Timer

The picture is taken ten seconds after the shutter release button is pressed.

- 1** Set the mode dial to or .
- 2** Press the / / / MF button to display on the LCD monitor.
- 3** Press the shutter release button.  
The self-timer is engaged and the self-timer lamp lights. The picture is taken approximately three seconds after the self-timer lamp starts to blink.



If you turn the LCD monitor on, the second count will be displayed.

Playing Back Images p.22

Taking picture with self-portrait Mode p.44

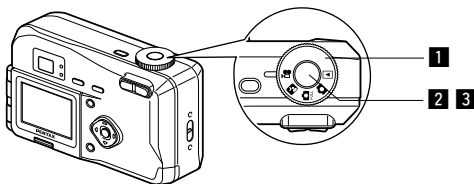

## Taking Movie Pictures (Movie Picture Mode)

This mode enables you to take moving images. The maximum length of one motion picture is 30 seconds.

### 1 Set the mode dial to .

The following information will be displayed on the LCD monitor.



- ① Flash Off
- ② Remaining shooting time
- ③ Remaining number of sets



### 2 Press the shutter release button.

Shooting will start.

You can change the size of the image using the Zoom button.

-  makes the image bigger
-  makes the image smaller

### 3 Press the shutter release button.

Shooting will end.

The remaining shooting time will be displayed.

## Keeping the shutter release button pressed

If you keep the shutter release button pressed for more than one second, pictures will be taken for as long as you keep the button pressed. Shooting stops when the button is released.

Playing Back Movie Pictures  p.71

### Caution

- The flash will not fire in Movie Picture mode.
- Continuous shooting is not possible in Movie Picture mode.
- The LCD monitor cannot be turned off in Movie Picture mode.
- Sound cannot be recorded in Movie Picture mode.

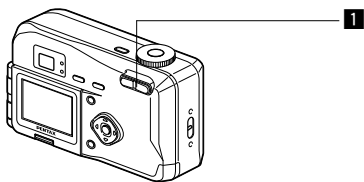

## Using the Zoom

You can use the zoom to take pictures in Tele or Wide mode.

### 1 Press the Zoom button in Capture mode.

 makes the subject larger

 makes the subject smaller

When the digital zoom function is disabled, you can take pictures at up to 3x magnification using the optical zoom.

When the digital zoom is enabled, you can further enlarge the subject to a maximum magnification equivalent to 7.5x.

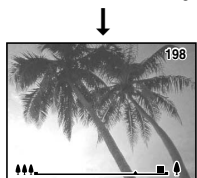
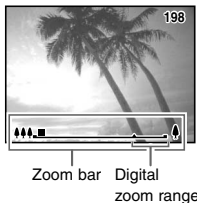

## Enabling the Digital Zoom Function

- 1 Press the Menu button in Capture mode.**

The [Rec.Mode] menu will be displayed.

- 2 Press the four-way controller (▼) to select [Digital Zoom].**

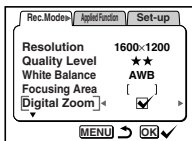

- 3 Use the four-way controller (▶) to select  (On).**

- 4 Press the OK button.**

The camera is ready to take a picture.



- When you turn the LCD monitor off, the digital zoom is disabled even if the digital zoom function is set to On.
- The digital zoom function is disabled when the Record mode is set to TIFF.

Saving the Digital Zoom Function Setting  p.68

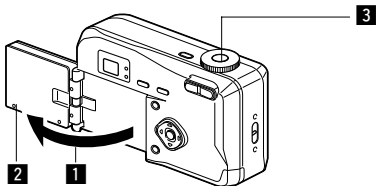

## Taking a Picture of Yourself (Self-Portrait Mode)

You can turn the LCD monitor over, enabling you to see yourself in the monitor when you want to take a picture of yourself or include yourself in the picture.

**1 Turn the LCD monitor over.**

**2 Reverse the image on the LCD monitor.**

When you press the Reverse button,  appears on the LCD monitor and the image is displayed in reverse from right to left.

**3 Press the shutter release button.**

The picture is taken.



- The image is not recorded in reverse.
- The menu screen is not reversed.
- If you press the Reverse button without opening the LCD monitor outwards, the image will be reversed on the LCD monitor.
- If you are taking pictures in low light conditions, use the self-timer to avoid camera shake when pressing the shutter release button.

Using the Self-Timer  p.39

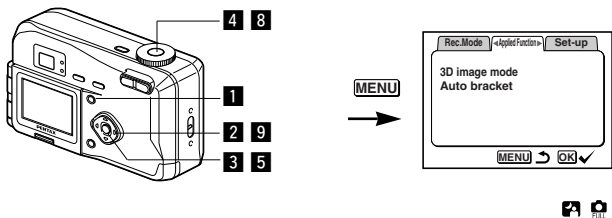

## Taking Stereo Pictures (3D image mode)

You can take 3D pictures using the LCD monitor and view them by the parallel method or cross method. If you print out the 3D pictures and look at them through the 3D image viewer provided, the image will appear in three dimensions.

**1** Select [3D Image mode] on the [Applied Function] menu and press the four-way controller (▶).

**2** Use the four-way controller (◀ ▶) to select [Parallel] or [Cross].

To view the picture with the 3D image viewer, select [Parallel]. You can also view it without the image viewer.

**3** Press the OK button.

**4** Press the shutter release button while watching the capture guide.

Take the picture so that the subject is in the shooting zone in the middle. The first image is taken and [Move camera to right] appears on the LCD monitor.

**5** Press the OK button.

Even if you press the shutter release button halfway, you can proceed to take the second image.

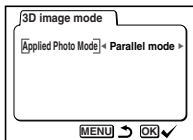

Shooting zone

**6** Move the camera to the right without changing your stance.

**7** Overlap the images.

The first image will appear in a semi-transparent state on top of the second image. Compose the picture so that the first semi-transparent image is superimposed on the outlines of the second real image.

If the overlapping images are hard to see, use the four-way controller to move the semi-transparent image and superimpose it on the real image.



The semi-transparent section is lengthened sideways and moves up and down when the four-way controller is pressed.



The semi-transparent section is lengthened longways and moves right and left when the four-way controller is pressed.

**8** Press the shutter release button.

The second image will be taken.

**9** Use the four-way controller (▲▼) to choose whether to continue shooting.

Choose whether to continue or end 3D shooting and press the OK button.

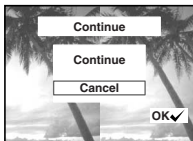

- 3D image picture cannot be taken when the Quality level is set to TIFF.
- Press the Menu button to end 3D shooting.
- A clear three-dimensional effect will not be achieved if the two images are taken in widely different positions (heights) or are not straight. When taking a person, you are recommended to ask your model to stay as still as possible and to take the second picture as quickly as you can. It is easier to take the pictures if you use a tripod or appropriate base.
- As a guide, the camera should be moved about  $1/40$  of the distance between the camera and the subject. For example, if the subject is 3m away, the distance the camera should be moved will be  $3\text{m} \times 40 = 7.5\text{cm}$ .



However, as the way people see three-dimensional images differs from person to person, there is no need to be too concerned. Refer to the table below for a simple guide to how far to move the camera.

Distance to subject	0.1 m	0.3 m	0.5 m	1 m	3 m	5m
Camera movement	0.5 cm	1 cm	1.5 cm	2.5 cm	7.5 cm	13 cm

### ● Viewing 3D pictures by the parallel method and cross method

As our eyes are positioned about 6~7cm apart, there is a very slight deviation between what we see with our right eye and what we see with our left eye. The difference is processed by our brain to produce a three-dimensional image. This principle is applied to taking and viewing 3D pictures.

3D pictures can be viewed by the parallel method where the left and right lines of vision are virtually parallel, as when looking at a distant scene, or the cross method where the left and right lines of vision are crossed, as when you cross your eyes. A certain amount of practice may be necessary to view 3D pictures without using the viewer.

### ● How to Assemble the 3D Image Viewer

Assemble the 3D image viewer supplied with the camera as shown below.

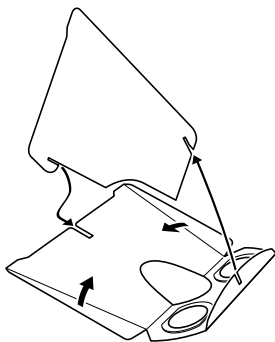

## ● How to view 3D pictures using the 3D image viewer

Print out the pictures so that they are about 11cm or 12cm wide and place the divider of the 3D image viewer in the middle of the two.

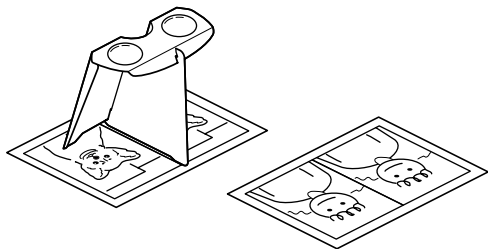

Viewing the images with a PC or Macintosh  p.82 or p.101



- As the distance between the left and right eyes differs from person to person, some people may have difficulty obtaining a three-dimensional effect even when looking at prints that are the same size. It may be especially difficult if the pictures are very large or very small. Try different sizes until the right effect is achieved.



- Never look at the sun through the 3D image viewer.
- Do not leave the 3D image viewer where it is exposed to direct sunlight as this may lead to fire.

- Example of a 3D picture



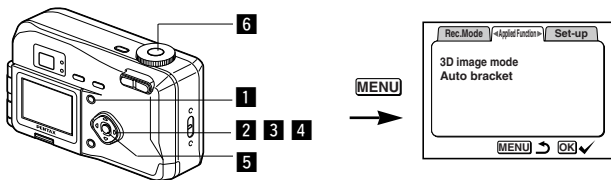

## Automatically Changing the Shooting Conditions (Auto bracket)

You can take pictures in succession while automatically changing the exposure, white balance, saturation, sharpness and contrast settings. Three pictures are taken in succession with different exposure settings. The other settings are automatically set for each picture.

**1** Select [Auto bracket] on the [Applied Function] menu.

**2** Use the four-way controller ( ◀ ▶ ) to select the conditions for bracket shooting.

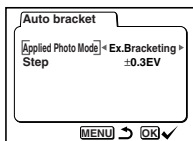

**3** Press the four-way controller ( ▼ ) to select [Ex. Bracketing] or [white balance].

The [Step] setting screen appears.

**4** Use the four-way controller ( ◀ ▶ ) to set the steps.

In addition to the NORMAL setting, you can take the 3 pictures in steps using a plus or minus setting.

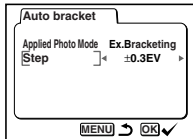

**5** Press the OK button.

The Bracket mode is set.

**6** Press the shutter release button.

**7** Use the four-way controller (▲▼) to choose whether or not you wish to continue bracket shooting.

Choose whether you wish to continue bracketing under the same conditions or end bracketing and press the OK button.

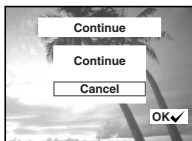

- Check the pictures you have taken using the Playback mode.
- If you set auto bracket when you set the Continuous Shooting mode, continuous shooting will be canceled.

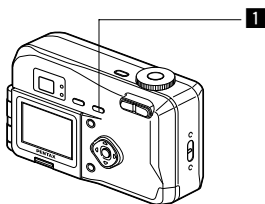

Playing Back Images  p.22

# Setting the Shooting Functions



## Selecting a Focus Mode

### ● Focus Mode

None	Auto	The camera is focused on the subject in the focusing area when the shutter release button is pressed halfway.
	Macro Mode	This mode is used when the distance to the subject is approx. 10cm-50cm (0.33ft-1.64ft). The camera is focused on the subject in the focusing area when the shutter release button is pressed halfway.
	Infinity-landscape mode	This mode is used for taking distant objects.
<b>MF</b>	Manual Focus Mode	The subject is brought into focus manually.

#### **1** Press the button in Capture mode.

The focus mode changes each time the button is pressed and the setting is displayed on the LCD monitor.

The camera is ready to take the picture in the set focus mode.



- The focus mode returns to [Auto] when the camera is turned off.
- The default setting of the focus mode is [Auto]. When the focus mode is [Auto], no icon is displayed on the LCD monitor.



If you take a picture while looking through the viewfinder when the focus mode is set on Macro, the range of the resulting picture may differ from what was seen in the viewfinder.

## Manual Focus

When the mode is set on **MF**, focus the camera on the subject manually while observing the enlarged display in the middle.



increases the distance to the focusing position



decreases the distance to the focusing position



- The Manual Focus mode is canceled when you exit the Capture mode.
- It is difficult to obtain the correct focus in Auto mode when taking pictures in a dark place. In this case, if you press the shutter release button halfway, AF spotbeam will be emitted, enabling the camera to focus more easily on the subject.

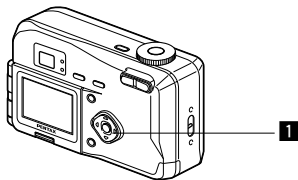

## EV Compensation

You can take pictures that are intentionally overexposed or underexposed.

### 1 Press the four-way controller ( ◀ ▶ ) in Capture mode.

Four-way controller ( ▶ )  
increases the EV compensation  
to a positive (+) level

Four-way controller ( ◀ )  
decreases the EV compensation  
to a negative (-) level



EV compensation level

The set level is displayed on the LCD monitor.



- The EV Compensation is disabled in the Auto mode.
- If you press ◀ or ▶ one time, or set to ± 0, the set level displayed on the LCD monitor will go off after three seconds.
- EV compensation is reset when power is off.
- You can save the Exposure Compensation setting by the Exp. comp. memory mode when the camera is being turned on.

Saving the EV Compensation  p.68



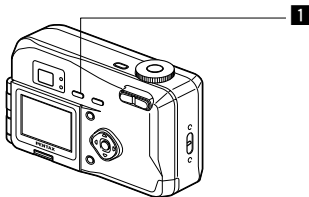

## Selecting the Flash Mode

None	Auto	The flash discharges automatically depending on the light conditions.
	Flash Off	The flash will not discharge.
	Flash On	The flash discharges regardless of the brightness.
	Auto + Red-eye Reduction	This mode reduces the phenomenon of red eyes caused by the light from the flash being reflected in the subject's eyes. The flash discharges automatically.
	Flash On + Red-eye Reduction	This mode reduces the phenomenon of red eyes caused by the light from the flash being reflected in the subject's eyes. The flash will discharge regardless of lighting conditions.



- The flash is off when the Capture mode is set to , continuous shooting, or infinity-landscape mode.
- The flash discharges once as the auxiliary light for the photometry when taking a picture in the flash mode.
- In [Auto + Red-eye Reduction] and [Flash On + Red-eye Reduction] modes, the flash discharges once to make subject's pupil smaller. And then, take a picture in the flash mode after a brief interval.

### 1 Press the button in Capture mode.

The flash mode changes each time the button is pressed and the set mode is displayed on the LCD monitor.

The flash lamp blinks red while the flash is charging. If the flash lamp lights red when you press the shutter release button halfway after charging is completed, the camera is ready to take the picture in the set flash mode.

Saving the Flash Mode p.68

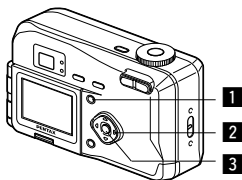

MENU

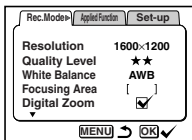

## Selecting the Recorded Pixels

You can choose the number of recorded pixels from [1600 × 1200], [1024 × 768] and [640 × 480].

- 1** Select [Resolution] from the [Rec.Mode] menu.
- 2** Use the four-way controller (◀ ▶) to change the size.
- 3** Press the OK button.

The camera is ready to take the picture.

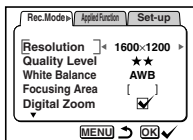

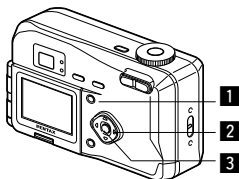

MENU

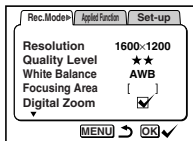

## Selecting the Quality Levels

You can choose the image compression rate.

TIFF	TIFF	The quality is the best and there is a high volume of image data.
★★★	BEST	The quality is better and there is a high volume of image data.
★★	BETTER	Standard level
★	GOOD	The quality is good and there is a low volume of image data.

**1** Select [Quality Level] from the [Rec.Mode] menu.

**2** Use the four-way controller ( ◀ ▶ ) to change the image quality.

**3** Press the OK button.

The camera is ready to take the picture.

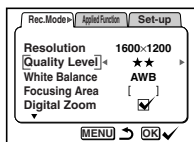

- If you select TIFF, the resolution is fixed at 1600 × 1210.
- If you select TIFF, the digital zoom is disabled.
- If you select TIFF, the 3D image picture cannot be taken.

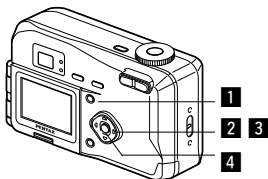

MENU

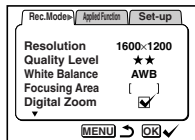

## Adjusting the Color Balance according to Lighting (White Balance)

You can take pictures in the actual colors that you see by adjusting the white balance according to the light conditions.

AWB	Auto	The camera adjusts the white balance automatically.
	Daylight	Use this mode when taking pictures outside in sunlight.
	Shade	Use this mode when taking pictures outside in the shade.
	Tungsten Light	Use this mode when taking subjects under electric or other tungsten light.
	Fluorescent Light	Use this mode when taking subjects under fluorescent light.
	Manual	Use this mode when taking pictures by adjusting the white balance manually.

- 1 Select [White Balance] from the [Rec.Mode] menu.**
- 2 Press the four-way controller (▶).**  
The white balance screen will be displayed.
- 3 Use the four-way controller (▲ ▼) to change the setting.**
- 4 Press the OK button twice.**  
The camera is ready to take the picture.

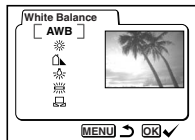

Saving the Color Balance p.68

## Manual Setting

- 1** Select [  ] on the white balance screen.
- 2** Point your camera at a blank sheet of paper so that it fills the screen.

- 3** **Press the shutter release button.**  
The white balance is automatically adjusted, [Complete] is displayed on the LCD monitor and the display returns to the menu screen.

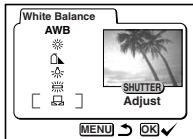

- 4** **Press the OK button.**  
The camera is ready to take the picture.

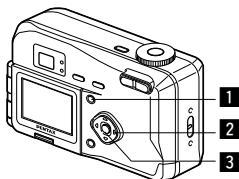

MENU

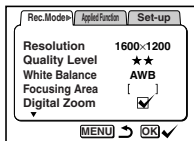

## Changing the AF Area (Focusing Area)

You can change the range and position of the autofocus area.

[ ]	Normal range (Wide)
[ ]	The autofocus range becomes smaller. (Spot)

**1** Select [Focusing Area] on the [Rec.Mode] menu.

**2** Use the four-way controller ( ◀ ▶ ) to change the setting.

**3** Press the OK button.  
The camera is ready to take the picture.

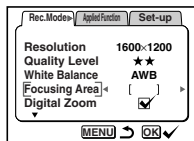

The AF area does not appear in the viewfinder. Always check the focusing area on the LCD monitor.

Save the AF Area p.68

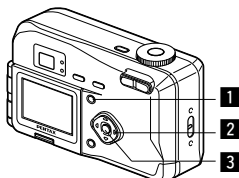

MENU

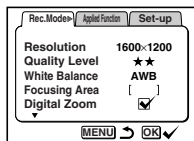

## Setting the Light Metering Range to Determine the Exposure (AE Metering)

You can choose which part of the screen to use to measure the brightness and determine the exposure.

	Multi segment	The exposure is determined by the entire screen.
	Center-weighted	The exposure is determined mainly by the center of the screen.
	Spot	The exposure is determined by the middle of the screen only.

**1** Select [AE Metering] on the [Rec.Mode] menu.

**2** Use the four-way controller ( ◀ ▶ ) to change the metering mode.

**3** Press the OK button.  
The camera is ready to take the picture.

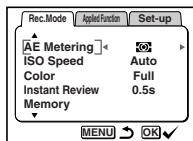

Saving the AE Metering Method p.68

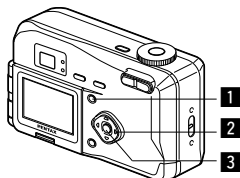

MENU

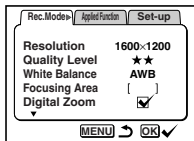

## Setting the ISO Speed (ISO Speed)

You can select the ISO speed to suit the brightness of the surroundings.

### ● ISO Speed

Auto	The camera sets the speed automatically.
100	Produces sharp images with little or no noise. Reduces the shutter speed in low light conditions.
200	Increases the shutter speed in low light conditions but there is more risk of noise.

**1** Select [ISO Speed] on the [Rec.Mode] menu.

**2** Use the four-way controller ( ◀ ▶ ) to change the ISO speed.

**3** Press the OK button.

The camera is ready to take the picture.

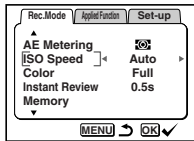

Saving the ISO Speed p.68



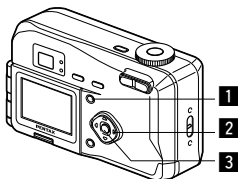

MENU

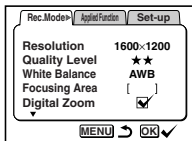

## Selecting the Color Mode (Color)

You can give atmosphere to your pictures by changing the colors to black and white or sepia.

### ● Color Mode

Full	The picture is taken in color
B & W	The picture is taken in black and white.
Sepia	The picture is taken in sepia.

**1** Select [Color] on the [Rec.Mode] menu.

**2** Use the four-way controller ( ◀ ▶ ) to change the Color mode setting.

**3** Press the OK button.

The camera is ready to take the picture.

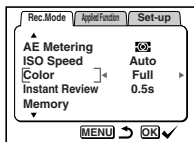

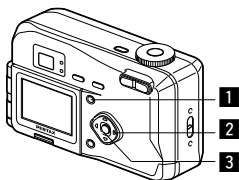

MENU

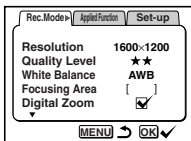

## Setting the Instant Review Time (Instant Review)

You can choose the Instant Review time from 0.5sec, 1sec, 2sec, 3sec, 5sec or Off (no display).

- 1 Select [Instant Review] on the [Rec.Mode] menu.**
- 2 Use the four-way controller ( ◀ ▶ ) to change the display time.**
- 3 Press the OK button.**

The camera is ready to take the picture.

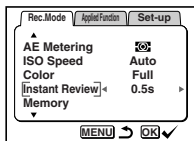

The Instant Review display setting is saved when the camera is turned off.

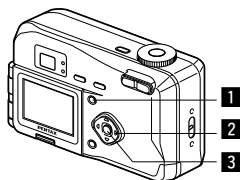

MENU

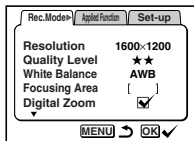

## Setting the Sharpness (Sharpness)

You can choose whether you want the image to have sharp or soft outlines.

- 1 Select [Sharpness] on the [Rec.Mode] menu.
- 2 Use the four-way controller ( ◀ ▶ ) to change the setting from [Hard (+)] to [Normal], [Soft (-)].
- 3 Press the OK button.

The camera is ready to take the picture.

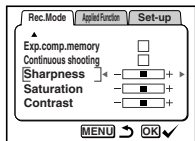

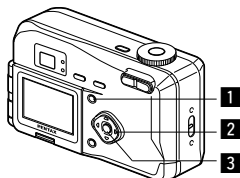

MENU

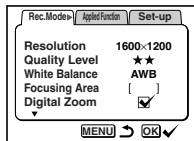

## Setting the Saturation (Saturation)

You can set the saturation.

- 1** Select [Saturation] on the [Rec.Mode] menu.
- 2** Use the four-way controller ( ◀ ▶ ) to change the setting from [High (+)] to [Normal], [Low (-)].
- 3** Press the OK button.

The camera is ready to take the picture.

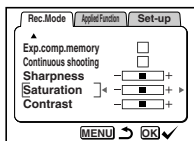

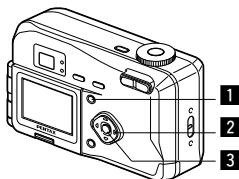

MENU

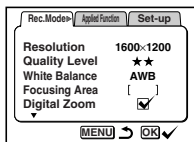

## Setting the Contrast (Contrast)

You can set the contrast.

- 1** Select [Contrast] on the [Rec.Mode] menu.
- 2** Use the four-way controller ( ◀ ▶ ) to change the setting from [High (+)] to [Normal], [Low (-)].
- 3** Press the OK button.

The camera is ready to take the picture.

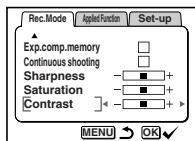

# Saving the Settings (Memory)

## Saving the Menu Items (Mode Memory)

You can choose whether you want the set values to be saved when the camera is turned off. If you select  (On), the settings will be saved in the status they were in immediately before the camera was turned off. If you select  (Off), the settings will be reset to the defaults when the camera is turned off.

Item	Description	Default Setting
Flash	The setting on the  button is saved.	<input checked="" type="checkbox"/>
White Balance	The [White Balance] setting on the [Rec.Mode] menu is saved.	<input type="checkbox"/>
Focusing Area	The [Focusing Area] setting on the [Rec.Mode] menu is saved.	<input type="checkbox"/>
Digital Zoom	The [Digital Zoom] setting on the [Rec.Mode] menu is saved.	<input checked="" type="checkbox"/>
AE Metering	The [AE Metering] setting on the [Rec.Mode] menu is saved.	<input type="checkbox"/>
ISO Speed	The [ISO Speed] setting on the [Rec.Mode] menu is saved.	<input type="checkbox"/>
Display	The LCD monitor display mode is saved.	<input type="checkbox"/>
File No.	The file number is saved. If a new CF card is inserted, the sequential file number is assigned.	<input checked="" type="checkbox"/>



Menu items not included in [Memory] will also be saved in the settings selected on the menus for each function when the camera is turned off.

- 1 Press the Menu button in Capture mode.
- 2 Press the four-way controller (▼) to select the [Memory] menu.

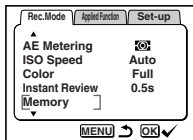

- 3 Press the four-way controller (▶). [Memory] menu will be displayed.
- 4 Use the four-way controller (▲▼) to select the item.
- 5 Use the four-way controller (◀▶) to switch  and .
- 6 Press the OK button.

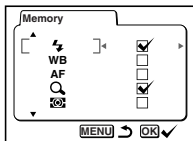

The camera is ready to take the picture.

## Saving the Exposure Compensation Setting

You can choose whether or not to save the exposure compensation setting when the camera is turned on.

- 1 Press the Menu button in Capture mode.
- 2 Press the four-way controller (▼) to select the [Exp. comp. memory] menu. [Exp. comp. memory] menu will be display.
- 3 Use the four-way controller ((◀▶)) to switch between  (On) and  (Off).
- 4 Press the OK button.

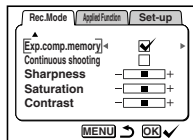

The camera is ready to take the picture.



EV compensation is reset when the camera is turned off.

# Playing Back Images on the Camera

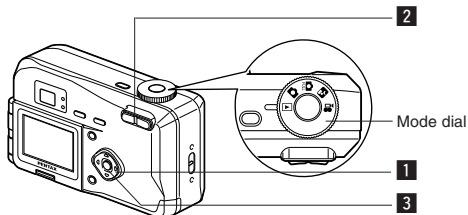

## Playing Back Still Pictures

See “Playing Back a Single Image” (p.23).

## Zoom Display

You can display images magnified up to four times. A guide to operation is displayed on the LCD monitor during magnification.

- 1 Set the mode dial to and choose the image you want to magnify with the four-way controller (◀ ▶).

- 2 Press on the Zoom button.  
The image will be magnified (1× to 4×).

- The following operations can be performed while the magnified image is displayed.

Four-way controller (▲ ▼ ◀ ▶)

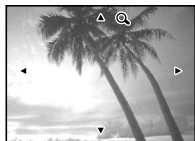

Moves the position to be magnified

Zoom button ( )

Makes the picture bigger

Zoom button ( )

Makes the picture smaller

Display button

Turns the guide marks on/off

- 3 Press the OK button.  
Zoom playback will end.



Movie pictures cannot be magnified.



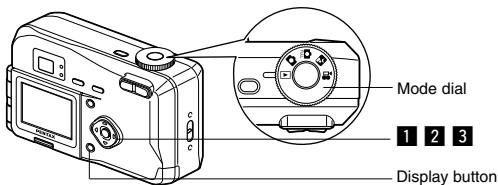

## Playing Back Movie Pictures

You can play back Movie pictures. A guide to operation is displayed on the LCD monitor during playback.

- 1** Set the mode dial to and choose the movie picture you want to play back with the four-way controller ( ).

- 2** Press the four-way controller ( ).

Playback will start.

- The following operations can be performed during playback.

Four-way controller ( ) :

Reverse playback

Four-way controller ( ) :

Forward playback

Four-way controller ( ) : Pause

Display button : Changes the Display mode

- The following operations can be performed while Pause is engaged.

Four-way controller ( ) : Frame forward

Four-way controller ( ) : Frame return

Four-way controller ( ) : Releases the Pause function

Display button : Changes the Display mode

- 3** Press the four-way controller ( ).

Playback ends.



## Displaying Shooting Information (Display mode)

You can display information on the LCD monitor when shooting. The information displayed can be changed by pressing the Display button.

### Display On

Information is displayed when shooting.

- ① Folder No.
- ② File No.
- ③ Protect symbol
- ④ Shutter speed/Aperture
- ⑤ Battery remaining
- ⑥ Shooting date



### Display Off

No information is displayed when shooting.



Display On

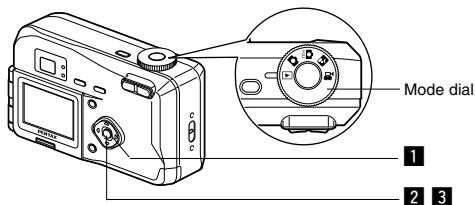







## Nine-image Display

You can display nine images at the same time.

**1** Set the mode dial to  and choose an image with the four-way controller (   ).

**2** Press the OK button.

Nine images will be displayed with the selected image in the center. Choose an image with the four-way controller (     ).

If you press the four-way controller (  ) while an image on the left row is selected, previous 9 images will be displayed. If you press the four-way controller (  ) while an image on the right row is selected, next 9 images will be displayed.



Selected image

**3** Press the OK button.

The screen will return to single-image display of the selected image.



For movie pictures, the first frame will be displayed.

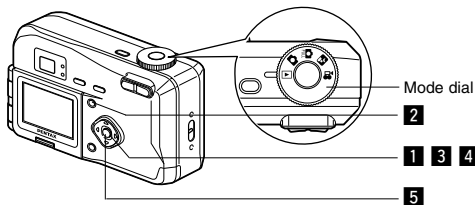

## Slideshow

You can play back all the images on the CF card continuously.

- 1** Set the mode dial to and choose the image with which to start the slideshow with the four-way controller ( ).
- 2** Press the Menu button.  
The [Playback] menu will be displayed.
- 3** Select [Slideshow] with the four-way controller ().
- 4** Use the four-way controller ( ) to change the playback interval.  
Choose from the following: 3s (3 sec), 5s (5 sec), 10s (10 sec), 20s (20 sec), 30s (30 sec).
- 5** Press the OK button.  
Playback will start at the set interval.
- 6** Press any button (except the shutter release button).  
The slideshow will stop.

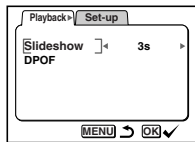



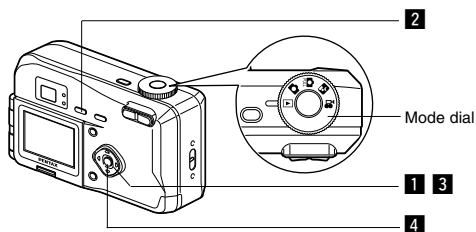

- The slideshow will continue until you press any button.
- In the case of movie pictures, when one movie picture has been played through, the next movie picture will be played regardless of the set playback interval.

# Erasing Images



## Erasing a Single Image

- 1** Set the mode dial to  and choose the image you want to erase with the four-way controller (   ).
- 2** Press the  button.  
The [Delete] menu will be displayed.
- 3** Select [Delete] with the four-way controller (  ).
- 4** Press the OK button.

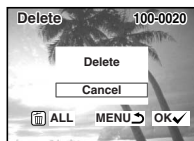

- You can also delete images from Instant Review (p.21) and Easy View (p.22).
- You cannot erase protected images (with the  symbol).

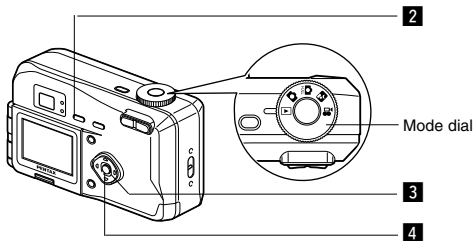

## Erasing All Images

You can erase all the images on the CF card.



- Once erased, images cannot be restored.
- Protected images cannot be erased.

- 1 Set the mode dial to .
- 2 Press the button twice.  
The [Delete All] menu will be displayed.
- 3 Select [Delete All] with the four-way controller ( ).
- 4 Press the OK button.

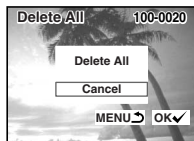

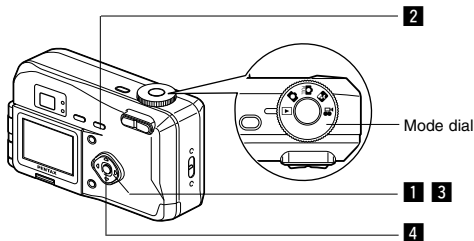

## Protecting Images from Deletion (Protect)

You can protect images from being accidentally erased.

- 1 Set the mode dial to and choose the image you want to protect with the four-way controller ( ).
- 2 Press the button.  
The [Protect] menu will be displayed.
- 3 Select [Protect] with the four-way controller ( ).
- 4 Press the OK button.



- Select [Unprotect] in step **3** above to release the Protect setting.
- If the image is protected, the symbol is displayed when the image is played back.

## Protecting All Images

You can protect all the images.

- 1 Set the mode dial to .
- 2 Press the button twice.  
The [Protect (All)] menu will be displayed.
- 3 Select [Protect] with the four-way controller ( ).
- 4 Press the OK button.



Even protected images will be erased by formatting a CF card.

# Viewing Images on a TV

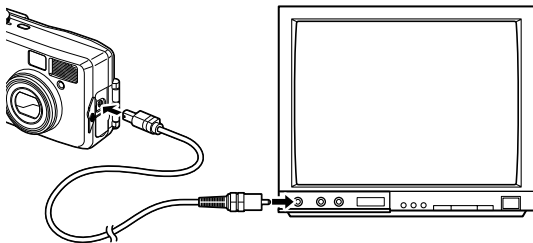

By using the video cable, you can capture and play back images on a TV or other equipment with a video IN jack. Make sure that both the TV and the camera are turned off before connecting the cable.

- 1** Open the terminal cover and connect the video cable.
- 2** Connect the other end of the video cable to the image input terminal of the TV.
- 3** Turn the TV and camera on.

Changing the Video Output Format  p.105



The LCD monitor is always turned off when the camera is connected to a TV.

If you intend to use the camera for a long time, use of the AC adapter (optional) is recommended. Refer to the operating manual for the TV or equipment to which the camera is connected.



# Setting the Printing Service

You can print the images on the CF card using a DPOF (Digital Print Order Format) compatible printer or at a printing service.

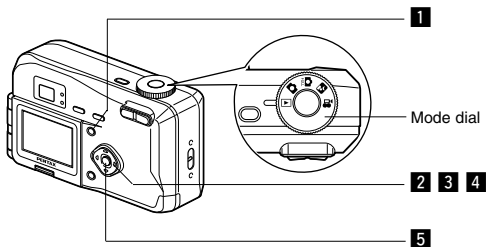

## Printing Single Image

Set the following items for each image.

● **Copies**

Set the number of prints up to a maximum of 99.

● **Date**

Specify whether you want the date inserted on the print or not.

**1** Press the menu button and select [DPOF] on the [Playback] menu.

**2** Use the four-way controller (◀ ▶) to choose the image for which you want to specify the number of prints and press the four-way controller (▼).

The frame will move to [Copies].



- 3 Use the four-way controller (◀ ▶) to select the number of prints and press the four-way controller (▼).**

The frame will move to [Date].



- 4 Use the four-way controller (◀ ▶) to select On or Off.**

On : The date will be printed

Off : The date will not be printed

- 5 Press the OK button.**

Prints can be made according to the settings.



- If DPOF settings have already been made for an image, the previously set number of prints and On/Off date setting will be displayed.



- You cannot set the printing service for movie pictures.
- Depending on the printer or printing equipment at the photo tab, the date may not be printed on the pictures even if the DPOF setting was made.

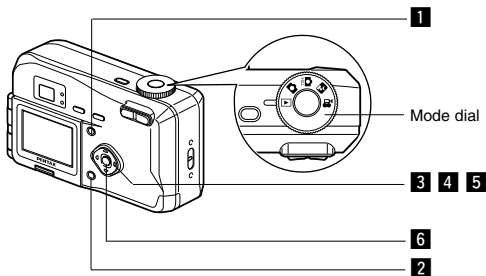

## Printing All Images

- 1** Select [DPOF] on the [Playback] menu.
- 2** Press the Display button.
- 3** Use the four-way controller (◀ ▶) to select the number of prints.  
You can specify up to 99 prints.
- 4** Press the four-way controller (▼).  
The frame will move to [Date].
- 5** Use the four-way controller (◀ ▶) to select On or Off.  
On : The date will be printed  
Off : The date will not be printed
- 6** Press the OK button.  
Prints can be made according to the settings.

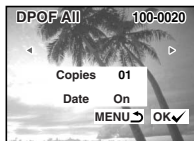

- The setting for a single image will be cancelled.
- When you specify the number of prints in the DPOF setting, the number applies to all the images. Before printing, check that the number is correct.
- The setting is not possible for movie pictures.

# Viewing Images with Windows PC

By using the provided USB cable (I-USB2) or card reader and image-browser software, you can transfer images recorded with the camera to a PC and edit them or print them out.

This section explains how to view images on a PC using the provided USB driver and software (S-SW5).

## About the included software

The included CD-ROM (S-SW5) contains the following software:

- USB driver
- Image viewing software (ACDSee™ 3.1)

## System environment

OS: Windows 98/2000/Me  
Windows XP Home Edition/Professional  
CPU: Pentium or later recommended  
Memory: 64MB or more  
Hard disk space: 15MB or more  
Standard equipped USB port

To view movie pictures on your PC, Direct X 8.0 and Media Player pre-installed on system, or QuickTime 3.0 or later are required. For Windows Me/XP, Media Player pre-installed on system, QuickTime 3.0 or later is required.

A starburst-shaped icon with the word "Caution" written inside in a bold, sans-serif font.

- Not compatible with Windows 95.
- When you connect the camera to your PC, you are recommended to use the AC adapter. If the battery power runs out while image data is being transferred, the data may be lost.

## Installing the software

The procedures for installing the necessary software are explained.

### Caution

- The installation procedure varies depending on the version of Windows (98/Me/2000). Before starting installation, check which version of Windows you have on your PC. If you are using Windows XP, see “Installing the USB Driver (Windows XP)” (p.90) for installation instructions.
- If you are using Windows 2000 or Windows XP (Professional), log in by the administrator before starting installation. Refer to your PC's operation manual for instructions on how to log in.

### Installing the USB driver (Windows 98/Me/2000)

- 1 Turn on your PC.**
- 2 Set the included CD-ROM (S-SW5) in the CD-ROM drive.**
- 3 Turn the camera off, and connect the PC and camera using an USB cable.**

Make sure that the CF Card has been inserted into the camera.

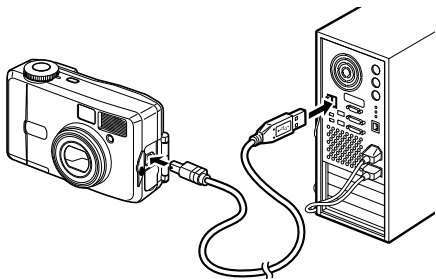

- 4 Turn the camera on.**  
The PC recognizes the camera and the [Add New Hardware Wizard] screen is displayed.

If you are using Windows 98, follow the procedure below to install the software. For Windows Me, see p.86, and for Windows 2000, see p.88.

● **Windows 98**

**5** Click [Next].



**6** Select [Search for the best driver for your device (Recommended)], and then click [Next].



**7** Select [Specify a location], and then click [Browse].

If any other item has been selected, click the check box to unselect it.



**8** Specify the [Win] folder in the CD-ROM drive and click [OK].

If you click the [+] symbol, the folder will open and display the files inside.



- 9** Make sure that the [Win] folder is selected and click [Next].



- 10** Make sure that [penusb.inf] is selected, then click [Next].  
Installation starts.



- 11** Click [Finish].  
Installation is completed and the [Wizard] screen is closed.



- 12** Turn the camera off and restart your PC.  
When Windows is up and running, turn the camera on.  
Make sure that the CF Card has been inserted in the camera.

- 13** Double-click the [My Computer] icon on the desktop.  
When the camera is turned on, the Removable Disk (Camera) icon appears in the window.

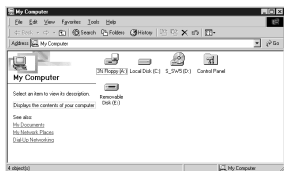

## ● Windows Me

- 5 Select [Specify the location of the driver (Advanced)], and then click [Next].



- 6 Select [Specify a location], and then click [Browse].

If [Removable Media] has been selected, click the check box to unselect it.



- 7 Specify the [Win] folder in the CD-ROM drive and click [OK].

If you click the [+] symbol, the folder will open and display the files inside.



- 8 Make sure that the [Win] folder is selected and click [Next].



- 9 Make sure that [penusbp.inf] is selected, then click [Next]. Installation starts.





**10** Click [Finish].

Installation is completed and the [Wizard] screen is closed.



**11** Turn the camera off and restart your PC.

When Windows is up and running, turn the camera on. Make sure that there is a CF card in the camera.

**12** Double-click the [My Computer] icon on the desktop.

When the camera is turned on, the Removable Disk (Camera) icon appears in the window.

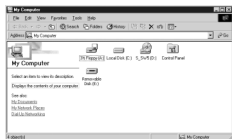

● Windows 2000

5 Click [Next].



6 Select [Search for the best driver for your device], and then click [Next].



7 Select [Specify a location], and then click [Next].  
If any other item has been selected, click the check box to unselect it.



8 Click [Browse].  
The [Files] screen is displayed.



9 Select the [Win] folder in the CD-ROM drive and make sure that [penusbp.inf] is displayed.  
And then click [Open].



- 10** Make sure that the [Win] folder containing the files to be copied is selected, and click [OK].



- 11** Make sure that [penusbp.inf] is selected, then click [Next]. Installation starts.

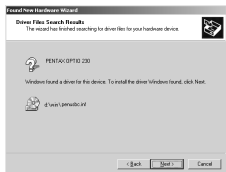

- 12** Click [Finish]. Installation is completed and the [Wizard] screen is closed.



- 13** Double-click the [My Computer] icon on the desktop. When the camera is turned on, the Removable Disk (Camera) icon appears in the window.



## Installing the USB driver (Windows XP)

- 1 Turn on your PC.
- 2 Set the CD-ROM (S-SW5) supplied with the camera in the CD-ROM drive.
- 3 Turn the camera off and connect the PC and camera using the USB cable.  
Make sure that the CF card has been inserted in the camera.

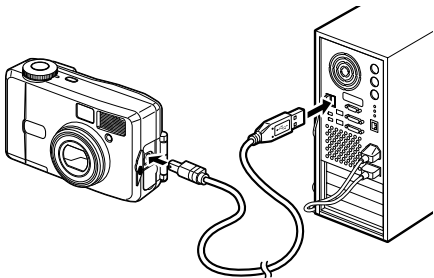

- 4 Turn the camera on.  
[New hardware has been located] will appear on the task bar and the [New Hardware Search Wizard] screen will be displayed.



- 5 Select [Install the software automatically (Recommended)] and click [Next].



- 6** When [The software has been successfully installed] message appears, click [Finish].

Installation is completed and the [Wizard] screen is closed. If the screen for choosing an automatic Windows operation is displayed, click [Cancel].



- 7** Click [My Computer] from [Start] menu.

After installing the software, make sure that a Removable Disk (Camera) has been added to [My Computer].



In the case of Windows XP, if the CF card has a volume label attached, the content of the volume label will be displayed instead of [Removable Disk]. If the CF card is new and has not been formatted, the manufacturer and capacity of the card will be displayed.

## Installing ACDSee™

When installing ACDSee™, recorded images can be viewed on your PC.

- 1 Turn on your PC.**
- 2 Set the CD-ROM (S-SW5) in the CD-ROM drive.**
- 3 Double click [My Computer].**
- 4 Double click the [CD-ROM drive] icon.**
- 5 Double click [English].**
- 6 Double click [setup.exe].**  
The Setup screen will appear. Follow the on-screen guidance and enter the registration information.
- 7 When the installation is completed, restart Windows.**

## Connecting the camera and PC

- 1 Turn on your PC.
- 2 Turn the camera off and connect the PC and camera using an USB cable.

Make sure that the CF Card is inserted.

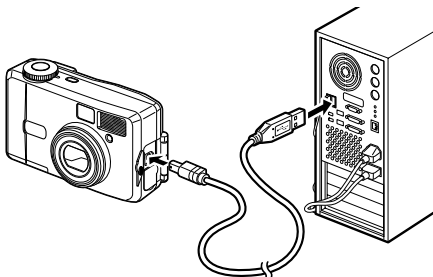

- 3 Turn on the camera.

The camera will be detected as [Removable Disk] in [My Computer].

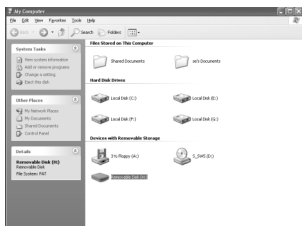

- Although images can be viewed and printed, image data is in the CF card of the camera. To save the image data in the CF card to another medium, refer to the instruction manual of your PC and move or copy files using Explorer, etc.
- You can edit images on your PC after moving or copying files there.
- In the case of Windows XP, if the CF card has a volume label attached, the content of the volume label will be displayed instead of [Removable Disk]. If the CF card is new and has not been formatted, the manufacturer and capacity of the card will be displayed.

## Viewing images on your PC

**1** Double click the [ACDSee™] icon on the desktop.

**2** Select the image to view.

Camera images can be found in [My Computer] → [Removable Disk (or the name on the volume label on the CF card, if there is one)] → [DCIM] → [xxxPENTX] (xxx is a 3-digit numeral) folder.



You can also view movie pictures operating the above procedures.



## Disconnecting the camera from your PC

### Disconnecting the camera from your PC (Windows 2000)

- 1 Double click  (Hot Plug icon) on the lower right task bar tray of the desktop.**

The [Remove Hardware] screen will appear.



- 2 Make sure [PENTAX USB Disk Device] is selected and click [Stop].**  
[Stop Hardware Device] screen will appear.



- 3 Make sure [PENTAX USB Disk Device] is selected and click [OK].**  
A message will appear.



- 4 Click [OK].**
- 5 Disconnect the USB cable from your PC and camera.**



For Windows 98/Me, there is no Hot Plug icon. When removing the camera, turn off the camera and disconnect the USB cable.

## Disconnecting your camera from your PC (Windows XP)

- 1 Click [Remove Hardware icon] on the task bar.
- 2 Make sure [PENTAX USB Disk Device] is selected and click [Stop].
- 3 Make sure [PENTAX USB Disk Device] is selected and click [OK].
- 4 A message confirming removal of the hardware will appear. Turn the camera off and disconnect your camera from your PC.

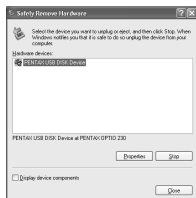



# Viewing Images with Macintosh

By using the provided USB cable or card reader and image-browser software, you can transfer images recorded with the camera to a PC and edit them or print them out.

This section explains how to view images on a PC using the provided USB driver and software.

## About the included software

The included CD-ROM (S-SW5) contains the following software:

- USB driver
- Image viewing software (ACDSee™)

## System environment

OS: Mac OS 8.6 or later (QuickTime 4.0 or later required)

CPU: Power PC 266MHz or higher

Memory: 8MB or more

Hard disk space: 6MB or more

Standard equipped USB port



To view movie pictures on your Macintosh, QuickTime 4.0 or later pre-installed on system is required.



When you connect the camera to your PC, you are recommended to use the AC adapter. If the battery power runs out while image data is being transferred, the data may be lost.

## Installing the software

The procedures for installing the necessary software are explained.

### Installing the USB driver (Only for Mac OS 8.6)

- 1 Turn on your Macintosh.**
- 2 Set the included CD-ROM (S-SW5) in the CD-ROM drive of your Macintosh.**
- 3 Copy the following 2 files to the [Extensions] folder within the System folder.**  
PENTAX-USB Storage Driver  
PENTAX-USB Storage Shim (E)
- 4 Restart your Macintosh.**



For MacOS 9.x or later, there is no need to install the USB driver.

### Installing ACDSee™

When installing ACDSee™, recorded images can be viewed on your Macintosh.

- 1 Turn on your Macintosh.**
- 2 Set the included CD-ROM (S-SW5) in the CD-ROM drive of your Macintosh.**
- 3 Double click [English] on the CD-ROM (S-SW5).**
- 4 Follow the on-screen guidance and enter the registration information and proceed with the installation.**

## Connecting the camera and your Macintosh

- 1 Turn on your Macintosh.**
- 2 Turn off the camera and connect your Macintosh and camera using an USB cable.**  
Make sure that the CF Card is inserted.

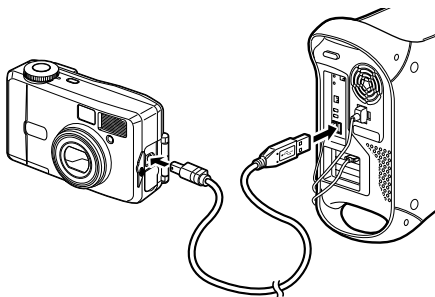

- 3 Turn on the camera.**  
The camera will be detected as [untitled] on the desktop. The folder name can be changed as desired.



- Although images can be viewed and printed, image data is in the CF card of the camera. To save the image data in the CF card to another medium, refer to the instruction manual of your Macintosh and move or copy files.  
You can edit images on your Macintosh after moving or copying files there.
- If the CF card has a volume label attached, the content of the volume label will be displayed instead of [Removable Disk]. If the CF card is new and has not been formatted, the manufacturer and capacity of the card will be displayed.

## Viewing images on your Macintosh

**1** Double click the [ACDSee™] folder on the hard drive.

**2** Double click the [ACDSee™] program icon.

**3** Choose an image you wish to view.

Camera images can be found in the [untitled] → [DCIM] → [xxxPENTX] (xxx is a 3-digit numeral) folder on the desktop.



- You can also view movie pictures operating the above procedures.
- If the CF card has a volume label attached, the content of the volume label will be displayed instead of [Removable Disk]. If the CF card is new and has not been formatted, the manufacturer and capacity of the card will be displayed.

## Disconnecting the camera from your Macintosh

**1** Drag the [untitled (or the name on the volume label on the CF card, if there is one)] folder on the desktop to Trash.

**2** Remove the USB cable from your Macintosh and camera.

## How to recall the [Set-up] menu

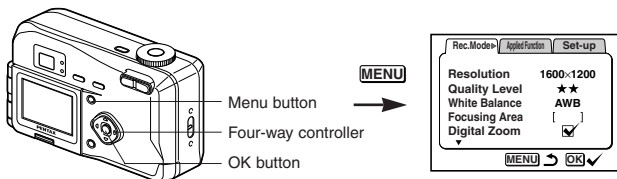

## Formatting a CF Card

Formatting will delete all the data on the CF card.

### Caution

- Do not open the CF card cover while the card is being formatted. The card may be damaged and become unusable.
- Formatting will delete protected data too.

- 1** Select [Format Card] on the [Set-up] menu.
- 2** Press the four-way controller (▶).  
The Format screen will be displayed.
- 3** Select [Format] with the four-way controller (▲).
- 4** Press the OK button.



Formatting will start. When formatting is completed, the camera is ready to capture or play back images.





Twice (in Full, night scene and movie modes)



Once (in Playback and auto mode)

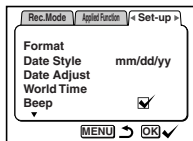

## Setting the Date Style

You can set the style in which the date is displayed on the camera. Choose [mm/dd/yy], [dd/mm/yy] or [yy/mm/dd].

- 1 Select [Date Style] on the [Set-up] menu.**
- 2 Use the four-way controller ( ◀ ▶ ) to change the date style.**
- 3 Press the OK button.**

The camera is ready to capture or play back images with the selected date style.



The time is set by [Date Adjust].

## How to recall the [Set-up] menu

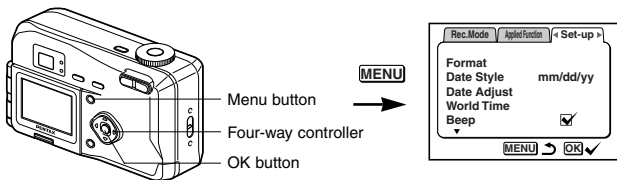

## Changing the Date/Time

You can change the initial date and time settings.

- 1 Select [Date Adjust] on the [Set-up] menu.**
- 2 Press the four-way controller (▶).**  
The date screen will be displayed.

See “Initial Settings” (p.15) for the setting procedure.

## Changing the Display Language

You can change the language in which the menus, error messages, etc. are displayed.

- 1 Select [Language] on the [Set-up] menu.**
- 2 Press the four-way controller (▶).**  
The language setting screen will be displayed.
- 3 Use the four-way controller (▲ ▼) to select the language.**
- 4 Press the OK button.**  
The menus will be displayed in the selected language.
- 5 Press the OK button.**  
The camera is ready to take or play back images.

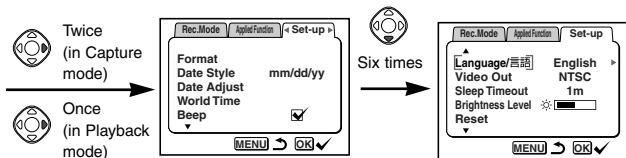

## Changing the Video Output Format

You can select the output format (NTSC or PAL) for taking or playing back images on a TV monitor.

- 1 Select [Video Out] on the [Set-up] menu.**
- 2 Use the four-way controller ( ◀ ▶ ) to change the video output format.**
- 3 Press the OK button.**  
The camera is ready to take or play back images.

## Setting the Beep

The beep sound can be turned on and off.

- 1 Select [Beep] on the [Set-up] menu.**
- 2 Use the four-way controller ( ◀ ▶ ) to select  (On) or  (Off).**
- 3 Press the OK button.**  
The camera is ready to take or play back images.

## How to recall the [Set-up] menu

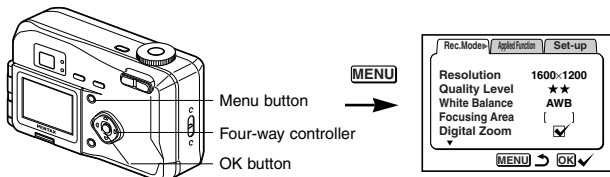

## Setting the World Time

The city and time selected in “Initial Settings” (p.15) serve as the World Time setting.

You can display the time in a city other than the Home Time city (World Time) when shooting or playing back.

**1** Select [World Time] on the [Set-up] menu.

**2** Press the four-way controller (▶). The World Time screen will be displayed.

**3** Switch  (On) and  (Off) with the four-way controller (◀▶).

: The time in the country selected in World Time will be displayed.

: The time in the country selected in Home Time will be displayed.



**4** Press the four-way controller (▼). The frame will move to [World Time].

**5** Use the four-way controller (◀▶) to select the World Time city and press the four-way controller (▼). The frame will move to [DST].

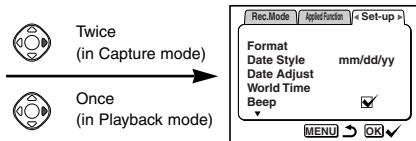

**6 Use the four-way controller ( ◀ ▶ ) to change the [DST] setting.**

- ☀  DST ON
- ☀  DST OFF

**7 Press the four-way controller ( ▼ ).**

The frame will move to [City].

Use the four-way controller ( ◀ ▶ ) to change the Home Time city and DST setting.

**8 Press the OK button.**

The camera is ready to capture or play back images with the time in the selected city.



See p.110 for the list of cities and code names.

## How to recall the [Set-up] menu

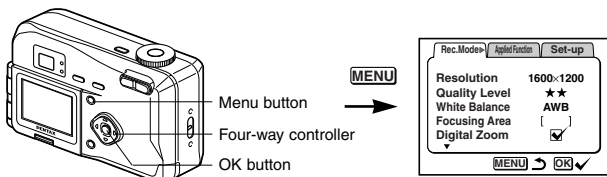

## Powersaving Function (Sleep Timeout)

You can set the LCD monitor to turn off automatically when no operation is performed for a fixed time.

- 1** Select [Sleep Timeout] on the [Set-up] menu.
- 2** Use the four-way controller ( ◀ ▶ ) to select [30sec], [1min], [2min] or [Off].
- 3** Press the OK button.

The camera is ready to take or play back images.



- This function will not work in Playback mode.
- This function is not available when playing back with the slideshow and using the USB cable.

## Auto Power Off Function

The camera turns off automatically when no operation is performed for a set time.



- The camera turns off 3 minutes after the last operation.
- If you do not perform any operation for one minute after the menu is displayed, the menu will be closed.

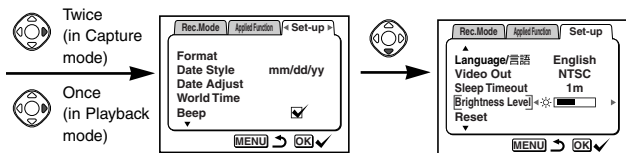

## Setting the Brightness Level

You can set the brightness of the LCD monitor.

- 1 Select [Brightness Level] on the [Set-up] menu.**
- 2 Use the four-way controller ( ◀ ▶ ) to select the brightness level.**  
Press ( ◀ ) to make the LCD monitor darker and press ( ▶ ) to make it brighter.
- 3 Press the OK button.**  
The camera is ready to take or play back images.

## Resetting to Default Settings (Reset)

You can reset all the settings other than the date and time, language, video output format and date style.

- 1 Select [Reset] on the [Set-up] menu.**
- 2 Press the four-way controller button ( ▶ ).**  
The Reset screen will be displayed.
- 3 Use the four-way controller ( ▲ ) to select [Reset].**
- 4 Press the OK button.**  
The camera is ready to take or play back images.

# List of City Names

Refer to the following list of city and code names for setting the world time.

Code	City Names	Code	City Names
PPG	Pagopago	THR	Tehran
HNL	Honolulu	DXB	Dubai
ANC	Anchorage	KHI	Karachi
YVR	Vancouver	KBL	Kabul
SFO	San Francisco	MLE	Male
LAX	Los Angeles	DEL	Delhi
YYC	Calgary	CMB	Colombo
DEN	Denver	KTM	Kathmandu
MEX	Mexico City	DAC	Dacca
CHI	Chicago	RGN	Rangoon
MIA	Miami	BKK	Bangkok
YTO	Toronto	KUL	Kuala Lumpur
NYC	New York	VTE	Vientiane
SCL	San Diego	SIN	Singapore
CCS	Caracas	PNH	Phnom Penh
YHZ	Halifax	SGN	Ho Chi Minh
BUE	Buenos Aires	JKT	Jakarta
SAO	Sao Paulo	HKG	Hong Kong
RIO	Rio de Janeiro	PER	Perth
MAD	Madrid	BJS	Beijing
LON	London	SHA	Shanghai
PAR	Paris	MNL	Manila
MIL	Milan	TPE	Taipei
ROM	Rome	SEL	Seoul
BER	Berlin	ADL	Adelaide
JNB	Johannesburg	TYO	Tokyo
IST	Istanbul	GUM	Guam
CAI	Cairo	SYD	Sydney
JRS	Jerusalem	NOU	Noumea
MOW	Moscow	WLG	Wellington
JED	Jeddah	AKL	Auckland







# Messages



Messages such as the following may be displayed on the LCD monitor during camera operation.



Memory card full	The CF card memory is full and no more images can be saved. Insert a new CF card or delete unwanted images. (p.13, p.75) Change the quality/size and try again. (p.56, p.57)
No images in camera	There are no images on the CF card.
Camera can not display this image	You are trying to play back an image in a format not supported by this camera. You may be able to display it on another brand of camera or PC.
This image is protected	The image you are trying to delete is a protected image. (p.77)
No card in camera	There is no CF card in the camera. (p.13)
Battery depleted	The battery is exhausted. Charge the lithium battery or replace with a new battery. (p.10, p.11)
Battery depleted. The image is not stored.	As the power ran out, the image you just captured has not been saved. Charge the lithium battery or replace with a new battery and take the picture again. (p.10, p.11)
Memory card error	Shooting and playback are impossible due to a problem with the CF card. Try displaying on a PC.

This card is not formatted	The card you have inserted is unformatted or has been formatted on a PC or other device. (p.102)
Image recording...	The image is being recorded on the CF card.
Movie recording...	The movie picture is being recorded on the CF card.
Changing setting	The protect setting or DPOF setting is being changed.
Formatting...	The CF card is being formatted.
Deleting image...	The image is being deleted.
Image folder can not be created.	The largest file number is assigned to an image and no more images can be saved. Insert a new CF card or format the CF card.
3D image cannot be selected with TIFF.	The Quality level is set to TIFF. The 3D image picture cannot be taken. Set to another Quality level.

# Troubleshooting

Problem	Cause	Remedy
Power will not come on	Battery is not installed	Check battery is installed. If not, install battery.
	CF card cover is open	Close CF card cover.
	Battery is installed incorrectly	Check orientation of battery. Reinsert battery as indicated by (+)(-) inside the battery chamber.
	Battery power is low	Insert a new battery or use the AC adapter.
No image on the LCD monitor	LCD monitor is set to OFF	Press Display button to turn LCD monitor on. (p.34, 72)
	Camera is connected to TV	LCD monitor remains off while camera is connected to TV.
	Image is displayed but is hard to see	Image on LCD monitor may be hard to see when taking pictures outside in sunlight. Adjust the brightness of the LCD monitor. (p.109)
Shutter release button will not release	Camera is set to Play mode	Set mode dial to    or  .
	Flash is charging	When flash lamp blinks red, flash is charging and no pictures can be taken. Lamp lights red when charging is completed.
	No available space on CF card	Insert CF card with available space or delete unwanted images. (p.13, 75)
	Recording	Wait until recording is finished.

Problem	Cause	Remedy
Subject is not in focus	Subject difficult to focus on	Subjects difficult to focus on using autofocus: objects with little contrast (blue sky, white walls, etc.), dark objects, finely patterned objects, fast-moving objects, scenery through window or net, etc. Lock focus on another object located at same distance (press shutter release button halfway), then aim at target and press shutter release button fully.
	Subject is not in focusing area	Position subject in square frame (focusing area) in middle of LCD monitor. If the subject is outside the focusing area, aim the camera at the subject and lock focus (press shutter release button halfway), then compose picture and press the shutter release button fully.
	Subject is too close	Set focus mode on  . (p.52)
	Focus mode is set on 	Normal pictures will be out of focus if taken with focus mode set on  .

Problem	Cause	Remedy
Picture is dark	Subject is too far away	Picture becomes dark if subject is too far away. Take picture within range of flash.
	Background is dark	When taking a picture of a person against dark background, such as night scene, the person may appear dark if the flash does not reach background even with correct exposure. Set to  mode to ensure both person and background are clear. (p.36)
Flash does not fire	Flash mode is set to Off	Set to Auto or  . (p.55)
	The Capture mode is set to  , continuous shooting, or Infinity-landscape mode.	Flash will not fire in these modes.

# Main Specifications

Type	Fully automatic compact-type digital still camera with built-in zoom lens
Effective Pixels	2.0 megapixels
Sensor	2.11 megapixels (total pixels) 1/2.7 inch interline transfer CCD with a primary color filter
Recorded Pixels	Still 1600 × 1210 pixels (TIFF only), 1600 × 1200, 1024 × 768 pixels, 640 × 480 pixels Movie 320 × 240 pixels
Sensitivity	Auto, manual (equivalent to ISO 100, 200)
File Format	Still JPEG (Exif2.2), TIFF, DCF, DPOF Movie AVI (Open DML Motion JPEG), 15fps
Quality Level	Excellent, Superior, Very Good, Good
Storage Medium	CompactFlash (CF) card Type I

## Image Storage Capacity

Quality levels Recorded pixels	TIFF	Best (★★★★)	Better (★★★)	Good (★★)	Movie images
1600 × 1210	2	—	—	—	—
1600 × 1200	—	Approx. 14	Approx. 29	Approx. 64	—
1024 × 768	—	Approx. 26	Approx. 53	Approx. 94	—
640 × 480	—	Approx. 53	Approx. 94	Approx. 133	—
320 × 240	—	—	—	—	2

- Exposure capacity when using a 16MB CF card

White Balance	Auto, Daylight, Shade, Tungsten Light, Fluorescent Light, Manual
Color Modes	Color, B&W, Sepia
Lens	Focal Length 5.8 mm–17.4 mm (Equivalent to 38 mm–114 mm in 35 mm format) Aperture F2.6–F5.0 Lens Composition 6 elements in 5 groups (one aspherical element) Zoom type Electrically driven Picture Range 38.4 mm × 28.5 mm (screen is filled) (using macro mode or manual focus at max. WIDE position) Lens Barrier Electrically driven
Digital Zoom	Capture mode Max. 2.5x (Combines with 3x optical zoom to give zoom magnification equivalent to 7.5x)
Viewfinder	Type Real-image zoom viewfinder Magnification Wide 0.41x, Tele 1.13x

LCD Monitor	1.6 inch TFD color LCD monitor (with backlight/brightness adjustment) With 180° swing out function	
Playback Function	Single-frame, 9-frame index, enlargement (max. 4x), scroll, slideshow, movie playback	
Focusing System	Type	TTL contrast detection autofocus system
	Focusing Range	Normal 0.4 (1.31 ft) to infinity (zoom fully extended) (From lens front) Macro 0.1 m (0.33 ft)–0.5 m (1.64 ft) (full zoom range) Landscape Infinity (zoom fully extended)
	Focus Lock	By half-pressing shutter release button
Manual Focus	0.1m to infinity	
Exposure Mechanism	AE Metering	TTL metering by sensor (Multi-segment, Center-weighted, Spot)
	Exposure Modes	Auto, Full, Night Scene, Movie
	Exposure Compensation	± 2 EV(Set in 1/3 EV steps)
	Movie	Recording time approx. 1 sec–30 sec.
Shutter	Type	Electronic/mechanical shutter
	Speed	Approx. 1/1500 sec.–4 sec.
Flash	Type	Auto flash with red-eye reduction function
	Flash Modes	Auto, Flash Off, Flash On, Auto + Red-eye Reduction, Flash On + Red-eye Reduction
	Working Range	Wide Approx. 0.7 m–5.0 m (ISO 200) Tele Approx. 0.5 m–2.7 m (ISO 200)
Drive Modes	Single-frame, Continuous, Self-timer	
Self-timer	Electronic control type, delay time: approx. 10 sec.	
Time Function	World Time setting for 62 cities (28 time zones)	
Power Supply	One CR-V3 lithium battery pack, two R6/AA batteries (alkaline, NiMH, lithium), AC adapter (optional)	
In/Out Port	USB/Video terminal (PC communication type USB1.1), external power supply terminal	
Video Output Format	NTSC, PAL	
Size	103.5(W) × 63.5(H) × 42(D) mm (excluding operating members)	
Weight	180 g (excluding batteries and CF card)	
Weight when shooting	230 g (including battery and CF card)	
Accessories	CR-V3 lithium battery pack, 3D image viewer, USB cable, software (CD-ROM), video cable, strap, operating manual	

# WARRANTY POLICY

All Pentax cameras purchased through authorized bona fide photographic distribution channels are guaranteed against defects of material or workmanship for a period of twelve months from date of purchase. Service will be rendered, and defective parts will be replaced without cost to you within that period, provided the equipment does not show evidence of impact, sand or liquid damage, mishandling, tampering, battery or chemical corrosion, operation contrary to operating instructions, or modification by an unauthorized repair shop. The manufacturer or its authorized representatives shall not be liable for any repair or alterations except those made with its written consent and shall not be liable for damages from delay or loss of use or from other indirect or consequential damages of any kind, whether caused by defective material or workmanship or otherwise; and it is expressly agreed that the liability of the manufacturer or its representatives under all guarantees or warranties, whether expressed or implied, is strictly limited to the replacement of parts as hereinbefore provided. No refunds will be made on repairs by non-authorized Pentax service facilities.

## Procedure During 12-month Warranty Period

Any Pentax which proves defective during the 12-month warranty period should be returned to the dealer from whom you purchased the equipment or to the manufacturer. If there is no representatives of the manufacturer in your country, send the equipment to the manufacturer, with postage prepaid. In this case, it will take a considerable length of time before the equipment can be returned to you owing to the complicated customs procedures required. If the equipment is covered by warranty, repairs will be made and parts replaced free of charge, and the equipment will be returned to you upon completion of servicing. If the equipment is not covered by warranty, regular charges of the manufacturer or of its representatives will apply. Shipping charges are to be borne by the owner. If your Pentax was purchased outside of the country where you wish to have it serviced during the warranty period, regular handling and servicing fees may be charged by the manufacturer's representatives in that country. Notwithstanding this, your Pentax returned to the manufacturer will be serviced free of charge according to this procedure and warranty policy. In any case, however, shipping charges and customs clearance fees to be borne by the sender. To prove the date of your purchase when required, please keep the receipt or bills covering the purchase of your equipment for at least a year. Before sending your equipment for servicing, please make sure that you are sending it to the manufacturer's authorized representatives or their approved repair shops, unless you are sending it directly to the manufacturer. Always obtain a quotation for the service charge, and only after you accept the quoted service charge, instruct the service station to proceed with the servicing.

- **This warranty policy does not affect the customer's statutory rights.**
- **The local warranty policies available from Pentax distributors in some countries can supersede this warranty policy. Therefore, we recommend that you review the warranty card supplied with your product at the time of purchase, or contact the PENTAX distributor in your country for more information and to receive a copy of the warranty policy.**



## **For customers in the USA**

### **STATEMENT OF FCC COMPLIANCE**

This device complies with Part 15 of the FCC Rules. Operation is subject to the following two conditions: (1) This device may not cause harmful interference, and (2) this device must accept any interference received, including interference that may cause undesired operation.

Changes or modifications not approved by the party responsible for compliance could void the user's authority to operate the equipment.

This equipment has been tested and found comply with the limits for a Class B digital device, pursuant to part 15 of the FCC Rules. These limits are designed to provide reasonable protection against harmful interference in a residential installation. This equipment generates, uses and can radiate frequency energy and, if not installed and used in accordance with the instructions, may cause harmful interference to radio communications. However, there is no guarantee that interference will occur in a particular installation. If this equipment does cause harmful interference to radio or television reception, which can be determined by turning the equipment off and on, the user is encouraged to try to correct the interference by one or more of the following measures:

- Reorient or relocate the receiving antenna.
  - Increase the separation between the equipment and receiver.
  - Connect the equipment into an outlet on a circuit different from that to which the receiver is connected.
- \* Consult the dealer or an experienced radio/TV technician for help.

## **For customers in Canada**

This Class B digital apparatus meets all requirements of the Canadian Interference - Causing Equipment Regulations.

## **Pour les utilisateurs au Canada**

Cet appareil numérique de la classe B respecte toutes les exigences du Règlement sur le matériel brouilleur du Canada.



The CE Mark is a Directive conformity mark of the European Community.

## Declaration of Conformity

According to 47CFR, Parts 2 and 15 for  
Class B Personal Computers and Peripherals

We: Pentax Corporation

Located at: 35 Inverness Drive East  
Englewood, Colorado 80112 USA  
Phone: 303-799-8000 Fax: 303-790-1131

Declare under sole responsibility that the product identified herein, complies with 47CFR Parts 2 and 15 of the FCC rules as a Class B digital device. Each product marketed, is identical to the representative unit tested and found to be compliant with the standards. Records maintained continue to reflect the equipment being produced can be expected to be within the variation accepted, due to quantity production and testing on the statistical basis as required by 47CFR §2.909. Operation is subject to the following two conditions: (1) This device may not cause harmful interference, and (2) This device must accept any interference received, including interference that may cause undesired operation. The above named party is responsible for ensuring that the equipment complies with the standards of 47CFR §15.101 to §15.109.

Product Name: PENTAX Digital Still Camera

Model Number: Optio230

Contact person: Customer Service Manager

Date and Place: April, 2002, Colorado

---

**MEMO**



**Asahi Optical Co., Ltd.** 2-36-9, Maeno-cho, Itabashi-ku, Tokyo 174-8639,  
JAPAN  
(<http://www.pentax.co.jp>)

**Pentax GmbH (European Headquarters)**

Julius-Vosseler-Strasse 104, 22527 Hamburg,  
GERMANY  
(HQ - <http://www.pentaxeuropa.com>)  
(Germany - <http://www.pentax.de>)

**Pentax U.K. Limited** Pentax House, Heron drive, Langley, Slough, Berks  
SL3 8PN, U.K.  
(<http://www.pentax.co.uk>)

**Pentax France S.A.** 12/14, rue Jean Poulmarch, 95106 Argenteuil Cedex,  
FRANCE

**Pentax Benelux B.V.** (for Netherlands)  
Spinveld 25, 4815 HR Breda, NETHERLANDS  
(<http://www.pentax.nl>)  
(for Belgium & Luxembourg)  
Weiveldlaan 3-5, 1930 Zaventem, BELGIUM  
(<http://www.pentax.be>)

**Pentax (Schweiz) AG** Widenholzstrasse 1 Postfach 367 8305 Dietlikon,  
SWITZERLAND (<http://www.pentax.ch>)

**Pentax Scandinavia AB** P.O. Box 650, 75127 Uppsala, SWEDEN  
(<http://www.pentax.se>)

**Pentax Corporation** 35 Inverness Drive East, Englewood, Colorado 80112,  
U.S.A.  
(<http://www.pentax.com>)

**Pentax Canada Inc.** 3131 Universal Drive, Mississauga, Ontario L4X 2E5,  
CANADA  
(<http://www.pentaxcanada.ca>)

<http://www.digital.pentax.co.jp>

- Printed on recycled paper
- Specifications and external dimensions are subject to change without notice.